

 **Stelrad**[®]

HOME

SERIES

BRINGING RADIATOR STYLE INTO UK HOMES

WELCOME

Your home is not just a house, it's a way for you to show your creativity and personality, creating a space that's both beautiful and practical.

Radiators give you the chance to do just that, bringing unique designs and finishes which can help your home stand out and give visitors an insight into who you really are.

Whether you're looking for super modern or traditional radiators in White, Anthracite grey or colour, our radiators are a great way to add style to your home.

But first, we are here to help you choose from the vast range.

You will also be able to find useful tips to help you find the right size – plus a handy Jargon Buster on page 14 to help you get started.

If you have any questions on which radiators will be the perfect fit for your home, our friendly Customer Services and Technical Team are just a phone call away on freephone 0800 876 6813.

Visit www.stelrad.com to order your colour samples and to purchase your radiators online.

Together we will make radiators easy and ensure you find 'the one' for you.



The UK's No.1 Radiator Brand



Beauty in
black and white
See page 118



Lecco
exclusive to
Stelrad Group
plc



Making
the most
of your space

See page 100



Chrome and
metallic stylish
finishes

See page 114



Adding a splash
of colour

See page 104



CONTENTS

Home Series Radiators

Classic Compact

Classic Compact	16
Classic Compact 900	18
Classic Compact K3	20
Classic Compact Xtra Protection	22
Classic Compact Vertical	24

Compact Vertical Line

Compact Vertical Line	28
Compact Vertical Line Concept	30
Compact Vertical Line Vertical	32
Compact Vertical Line Vertical Concept	34

Compact Horizontal Line

Compact Horizontal Line	36
Compact Horizontal Line Concept	38

Compact Flat

Compact Flat	40
Compact Flat Concept	42
Compact Flat Vertical	44
Compact Flat Vertical Concept	46

Concord

Concord Lo-line Coloured	48
Concord Plane	50
Concord Plane Coloured	52
Concord Vertical	54
Concord Vertical Concept	56
Concord Vertical Coloured	58
Concord Chrome Vertical	60
Concord Slimline	62
Concord Slimline Concept	64
Concord Slimline Coloured	66

Column

Column Horizontal	68
Column Concept	70
Column Horizontal Coloured	72
Column Vertical	74
Column Vertical Concept	76
Column Vertical Coloured	78
Cast Iron Column	80

Low Surface Temperature

LST Standard Horizontal Line	82
LST i Plus Horizontal Line	84

Heavy Duty

Heavy Duty Deco	86
Heavy Duty Planar	88

Home Series Towel Radiators

Bathroom Towel Radiator - curved	92
Bathroom Towel Radiator - straight	94
Mini Bathroom Towel Radiator	95
Matte Black Towel Rail	98
Stainless Steel Towel Rail	100
Como	102
Caliente Rail	104
Concord Rail	108
Concord Side Chrome	110
Concord Side Concept	112
Lecco	114
Ultra	116
Vertical Ultra	118
Sizes, Heating Specifications	120
Accessories	156

Exclusive
to Stelrad
Group plc

Handy hints & tips

Deciding on the right radiator or towel rail	8
Colour Guide	10
Jargon Buster	14
Trending:	
Inspiration in black and white	26
Making a statement with colour	90
Small on space, big on style	96
Marvellous metallics	106
Our Customers love us	158

HOME
SERIES

STELRAD RADIATORS MADE IN THE UK SINCE 1936

It's easy to see why Stelrad Radiators is the UK's number one radiator brand. With a rich heritage in manufacturing high quality, stylish modern radiators since 1936, it's safe to say we know a thing or two about heating.

We understand that purchasing a new radiator can be daunting, which is why our expert research team is dedicated to continually developing innovative products. To widen our extensive range to enable you to choose from the largest selection of technically-advanced radiator styles and sizes in the UK.



DECIDING ON THE RIGHT RADIATOR OR TOWEL RAIL

Where to start?

You don't have to be limited by the size and style of radiator that you're replacing, there are loads of options to choose from, which will fit with your style and generate the right amount of heat for your room.

In this brochure, we'll take you through what you need to consider when buying your new radiator or towel rail.

How do I choose the right radiator or towel rail?

The first thing you need to do is calculate how much heat you need in your room, using Stelrad's STARS basic or advanced heat loss calculator. Your plumber or installer can help you with heat loss calculations.

Using Stelrad's online heat loss calculator, your plumber or installer can add in the details, such as your room dimensions, window size(s) and wall. The calculator then gives you the required BTUs and Watts you will need to efficiently heat your room to a comfortable temperature.

If it's a large room, you can choose multiple radiators or towel rails within a range to reach the heat you need.

Need help?

Call our friendly Customer Service and Technical Team on freephone **0800 876 6813** or ask us a question using Live Chat on our website.

Consider your room

Use the suitability table to see what options you should choose from.

Room suitability	Bedroom	Hallway	Kitchen	Living Room	Bathroom	Other	Warranty
Horizontal radiators, including lo-line options	Yes	Yes	Yes	Yes	Yes*	Yes	5 – 10 years
Vertical radiators, including panel and tubed options	Yes	Yes	Yes	Yes	Yes*	Yes	5 – 10 years
Column radiators, including Steel and Cast Iron options	Yes	Yes	Yes	Yes	Yes*	Yes	5 – 10 years
Xtra Protection Radiators (ideal for humid rooms – see pg 18 for details)	Yes	Yes	Yes	Yes	Yes	Yes	5 – 10 years
LSTs (a radiator with a cover which doesn't get too hot to touch – see pages 38-40 for details)	Yes	Yes	Yes	Yes	Yes*	Yes	5 – 10 years
Towel Rails		Yes	Yes		Yes	Yes	5 – 10 years

*Horizontal and vertical steel panel radiators, which are installed in high humidity rooms (including bathrooms, kitchens & shower rooms etc...) are limited to a 12-month parts and labour warranty.

Then choose which shape you like:

Radiators:

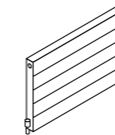

Horizontal



Vertical

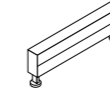

Lo-Line

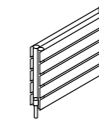

Tubed

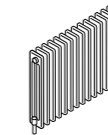

Columns

Towel rails:



Round tubes

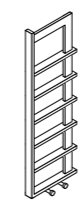

Square tubes



Flat tubes

With this in mind, you can now use the following pages to look at our wide selection of radiators and towel rails.

Once you've selected your product, use pages 122-154 to see what sizes you need to fulfill the heat requirements for your room.

COMPLETE THE LOOK BY CHOOSING YOUR OWN COLOUR

These days you are not limited to a traditional white radiator, you have the freedom to choose the most suitable colour radiator which will complement the colour scheme of your room.



Look out for these swatches

These 'made to order' options have up to an 8 week lead time and once ordered, cannot be cancelled or returned.

To request up to 5 colour samples, please email Sales@Stelrad.com or call **0800 876 6813** with your choices and address details.

The colours shown are reproduced as accurately as printing processes will allow.

COLOUR GUIDE



COLOURS IN STOCK



**RAL 9016
Glossy
Traffic White***

Classic, Compact Xtra Protection, Compact Vertical, Compact K3, Vertical Line, Vertical Line Vertical, Horizontal Line, LST Standard Horizontal Line, LST i Plus Horizontal Line, Flat, Flat Vertical, Concord Plane, Concord Vertical, Concord Slimline, Column Horizontal, Column Vertical, Classic Towel Rail.

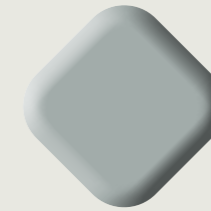

**Brushed
Stainless Steel**

Stainless Steel Towel Rail, Como, Lecco.

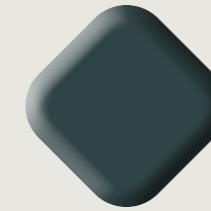

**RAL 7016
Glossy
Anthracite Grey****

Vertical Line Concept, Column Concept, Horizontal Line Concept, Flat Concept, Horizontal Line Vertical Concept, Flat Vertical Concept, Column Vertical Concept, Concord Vertical Concept, Concord Slimline Concept.

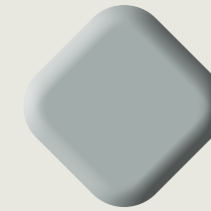

**Polished
Stainless Steel**

Stainless Steel Towel Rail, Lecco.

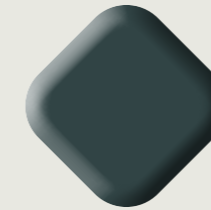

**VOV12
Matt
Anthracite Grey**

Concord Side Concept.

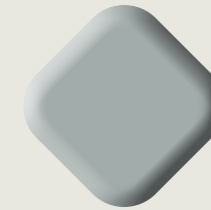

Chrome

Classic Towel Rail, Concord Side Chrome, Concord Chrome Vertical.

*Also available as a made to order colour for the Ultra and Vertical Ultra

**Also available as a made to order colour option for the Caliente Rail, Concord Rail, Ultra and Vertical Ultra.

COLOURS FOR CAST IRON COLUMN, CALIENTE RAIL, CONCORD RAIL, ULTRA & VERTICAL ULTRA



GLOSSY FINISHES (SMOOTH)



MATT FINISHES (SMOOTH)



METALLIC FINISHES (SMOOTH)



NATURAL CAST

METALLIC FINISHES (TEXTURED)



Please note on the Ultra and Vertical Ultra only the front fascia panel can be coloured. Where the product is 1000mm or 1200mm, the emitter, top grille and side panels are black. If the product is 1800mm or 2000mm the emitter, top grille and side panels are white.

COLOURS FOR COLUMN COLOURED & CONCORD COLOURED







RAL COLOURS



METALLIC COLOURS



JARGON BUSTER

Btu/hr	British Thermal Unit per hour is the standard measurement used to state the amount of output of any heat generating device.
Delta Δt	Refers to the difference in temperature between the water circulating in the central heating system and that of the ambient temperature. It is important to use the correct Δt when selecting your radiators, as the same radiator will have different outputs at different water temperatures.
Delta Δt_{50}	Δt_{50} is the UK standard, however Stelrad also quote at lower levels for lower water temperature systems.
Heat loss	Heat loss is the amount of heat a room loses, it is therefore an important calculation when determining what size radiator is required to heat a room to the correct level.
K1	Also known as Type 11, is a type of radiator with 1 radiator panel and 1 set of convection fins. 
K2	Also known as Type 22, is a type of radiator with 2 radiator panels and 2 sets of convection fins. 
K3	Also known as Type 33, is a type of radiator with 3 radiator panels and 3 sets of convection fins. 
P+	Also known as Type 21, is a type of radiator with 2 radiator panels and 1 set of convection fins. 
P2	Also known as Type 20, is a type of radiator with 2 radiator panels and no convection fins. 
RAL	A European wide colour matching system.
UIN	Is the unique identification number for Stelrad products.
Warranty	The warranty covers any defect that is attributable to a manufacturing, assembly or material fault. Further details available on request.
Watts	Is another measurement for heat output.



*Vertical Radiator:
A slim radiator that
saves space by using
wall height*
See page 24 & 127



*High
Heat Output:
Efficiently heats
larger spaces*
See page
20 & 125



*Column Radiator:
A classic design
for traditional or
vintage styles*
See page 76 & 141

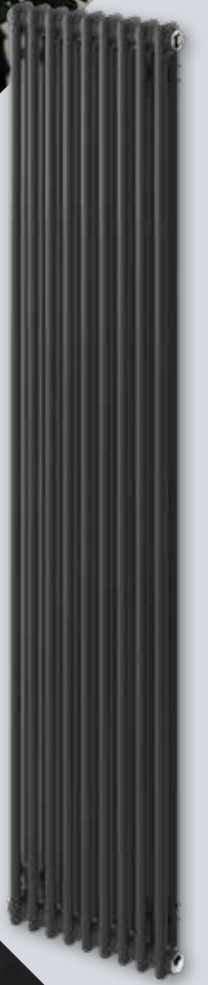

*Single or
Double Tubes:
Single has one surface;
double provides
more heat*
See page
50 & 133





Classic Compact

The Stelrad Home Series Classic Compact is one of the most popular ranges and looks at home in any interior setting.

300mm - 3000mm

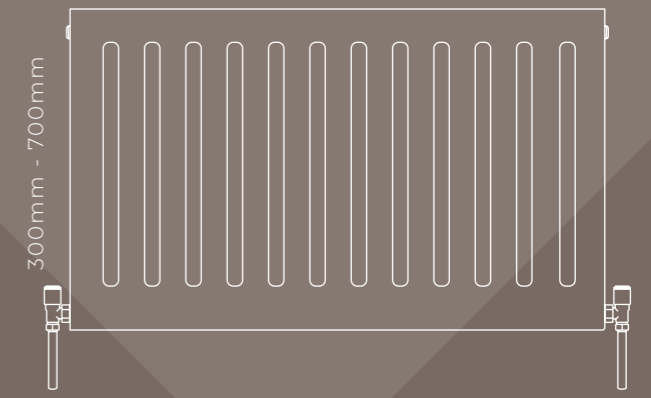

✓
IN STOCK

10
YEAR
WARRANTY



Only available
in Traffic White

Classic Compact 900

The Stelrad Home Series Classic Compact 900 offers a smart, stylish look with excellent performance.

400mm - 1000mm

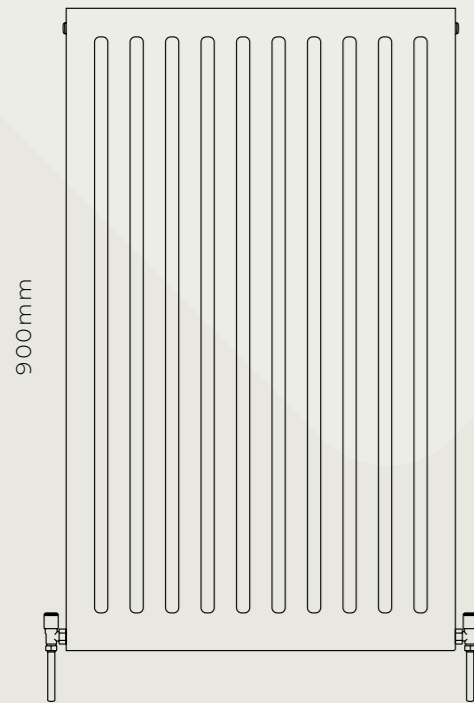

Only available
in Traffic White





Classic Compact K3

Ideal for where a high heat output is required or to be paired with low temperature heating systems, that's the Stelrad Home Series Classic Compact K3.

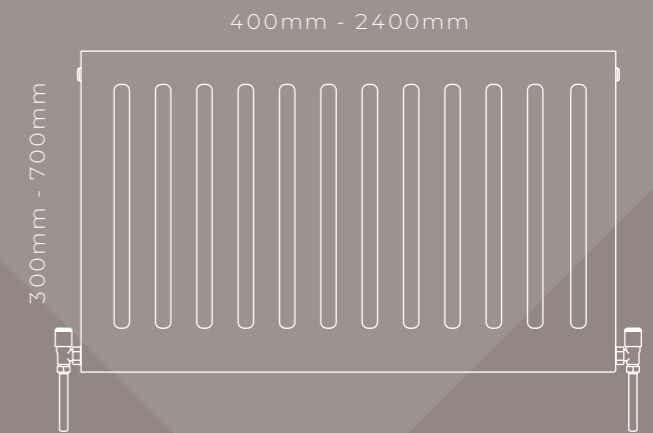

✓
IN STOCK

10
YEAR
WARRANTY



Only available
in Traffic White

Classic Compact Xtra Protection

The Stelrad Home Series Classic Compact Xtra Protection radiator is perfect for bathrooms, showers or wet rooms with its zinc coating.

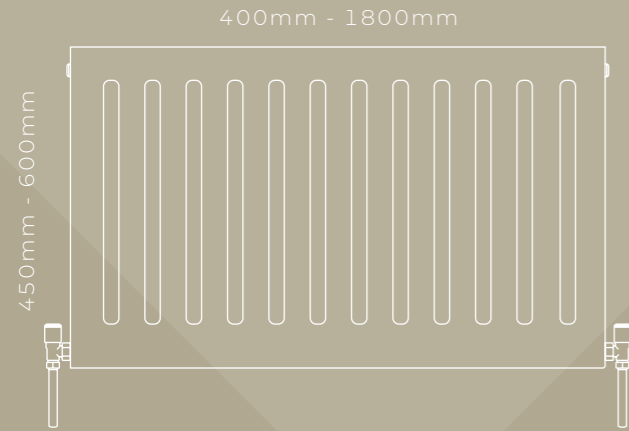

Only available
in Traffic White



5
YEAR
WARRANTY



IN STOCK



Classic Compact Vertical

The Stelrad Home Series Classic Compact Vertical offers a smart, stylish look with excellent performance.

300mm - 700mm

1600mm - 2200mm

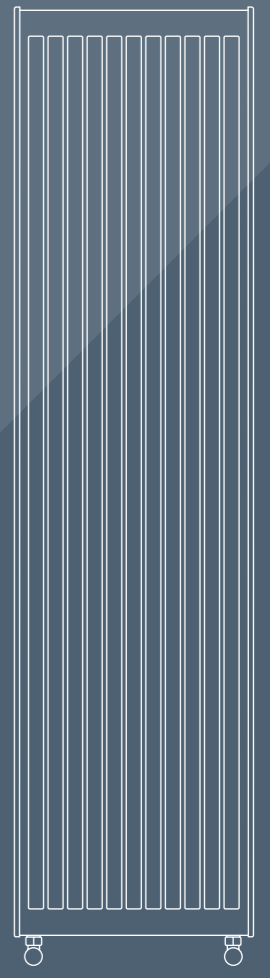

✓
IN STOCK

10
YEAR
WARRANTY



Only available
in Traffic White

INSPIRATION IN BLACK AND WHITE

Concord Vertical

See page 54.

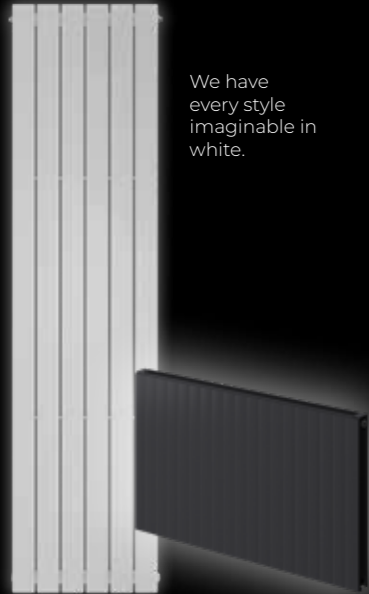

We have every style imaginable in white.

The Compact Vertical Line Concept in Anthracite grey is a great choice for this trend.

See page 30.

Black and white can be just as quirky and personal as more colourful decors, a primary colour scheme lends itself to an elegant and contemporary finish. Rather than lacking in vibrance, it provides the perfect backdrop for just a few hints of an accent shade, should you wish to add one.



Metallic radiators look great in a monochrome setting

The Como stainless steel radiator works really well in a monochrome setting, adding a dash of luxury.

See page 102.

Column Horizontal - see page 68.



Sometimes forgoing colour for a classic palette can really pay off, and this black and white bathroom is proof. A modern design is sure to inspire your own space.

Vertical Ultra - Graphite black

See page 118.





Compact Vertical Line

The Stelrad Home Series Compact Vertical Line adds a strong, bold appeal to an already attractive designer radiator.

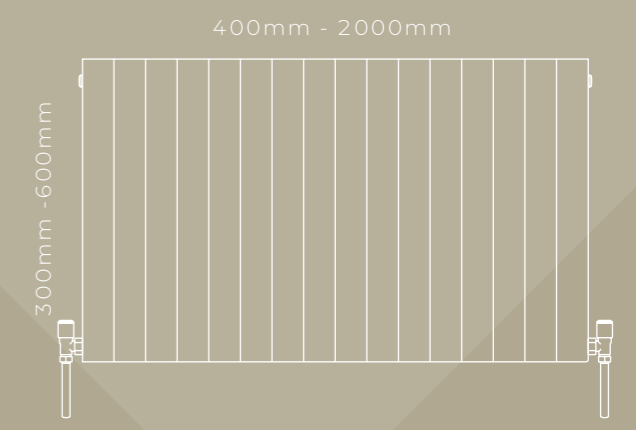

 IN STOCK

10
YEAR
WARRANTY

 Only available
in Traffic White

Compact Vertical Line Concept

The Stelrad Home Series Compact Vertical Line Concept in Anthracite grey adds a modern feature to any room.

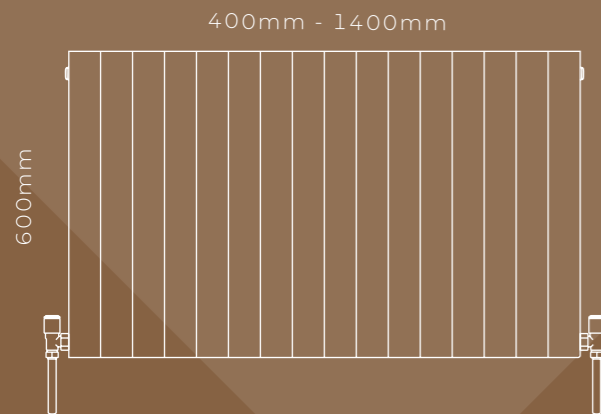

Only available
in Anthracite grey



10
YEAR
WARRANTY



IN STOCK



Elegant lines for
an elegant look

Compact Vertical Line Vertical

The Stelrad Home Series Compact Vertical Line Vertical is an attractive slim vertical radiator option, featuring an elegant lined front face, adding style to any modern home.

400mm - 600mm

1800mm

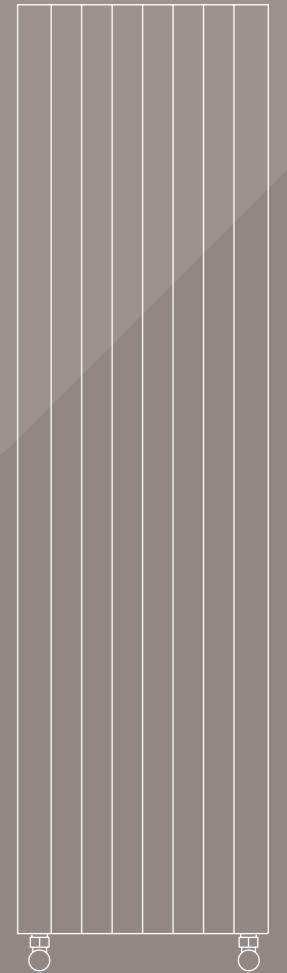

Only available
in Traffic White

Compact Vertical Line Vertical Concept

The Stelrad Home Series Compact Vertical Line Vertical Concept, features a fashionable vertical lined front face in the popular Anthracite grey.

400mm - 600mm

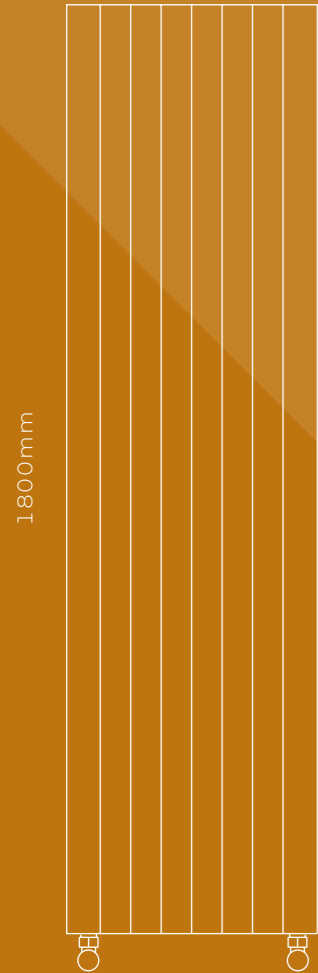

Only available
in Anthracite grey



10
YEAR
WARRANTY



IN STOCK





Compact Horizontal Line

The sleek lines of the Home Series Compact Horizontal Line make it an easy choice when looking for a designer radiator.

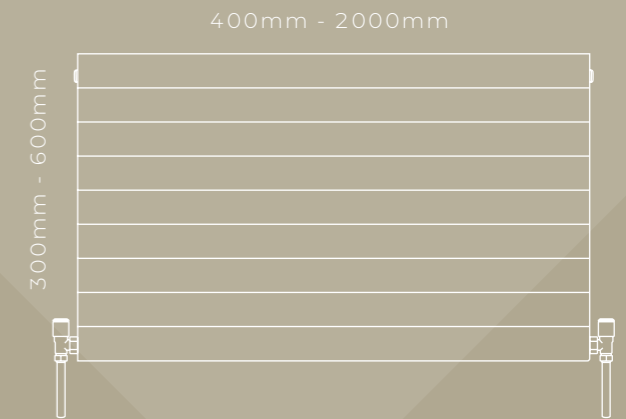

10
YEAR
WARRANTY



Only available
in Traffic White

Compact Horizontal Line Concept

The Stelrad Home Series Compact Horizontal Line Concept in Anthracite grey adds a cool and contemporary fashion statement that'll complement any choice of décor.



The Anthracite grey looks great with a neutral palette



Only available in Anthracite grey





Compact Flat

The Stelrad Home Series Compact Flat radiator features a stunning, simplistic finish and a smooth flat face making it the ultimate in minimal design.

400mm - 2000mm

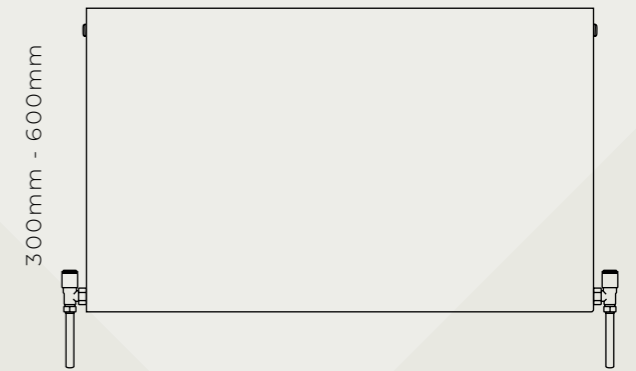

Only available in Traffic White

Compact Flat Concept

The Stelrad Home Series Compact Flat Concept offers a minimalist design which is complemented by the elegance of its Anthracite grey finish.

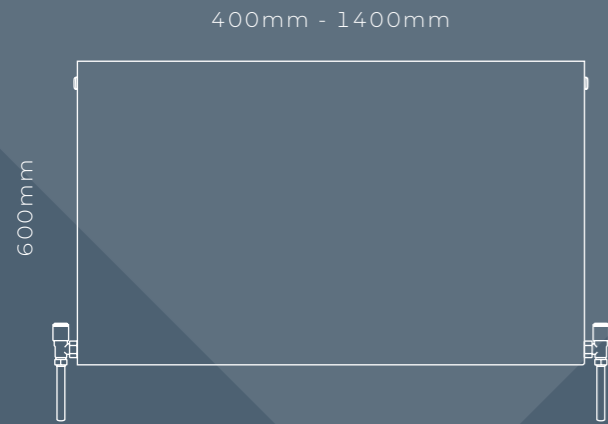

Only available
in Anthracite grey



10
YEAR
WARRANTY





Compact Flat Vertical

The Stelrad Home Series Compact Flat Vertical is a popular vertical radiator that adds minimalist style to complement any room.

400mm - 600mm

1800mm

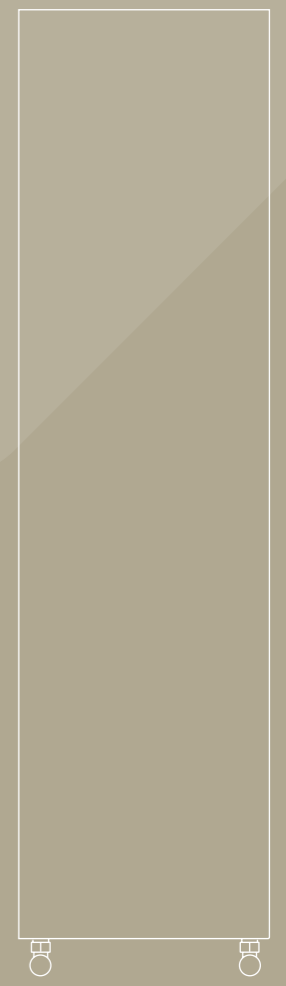

✓
IN STOCK

10
YEAR
WARRANTY



Only available
in Traffic White

Compact Flat Vertical Concept

The Stelrad Home Series Compact Flat Vertical Concept has a sleek and simplistic finish in the dignified Anthracite grey, making this a popular choice to complement any décor.

400mm - 600mm

1800mm

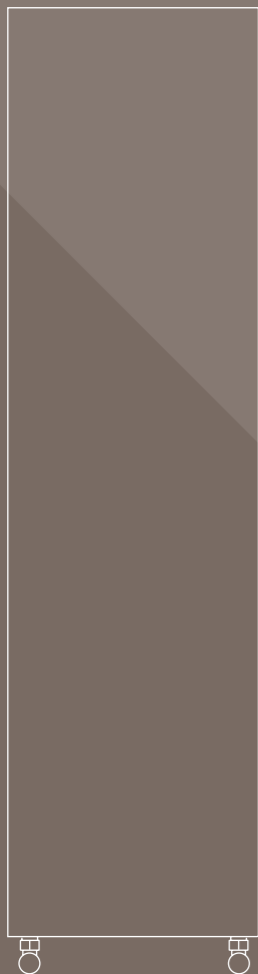

Only available
in Anthracite grey



10
YEAR
WARRANTY



IN STOCK

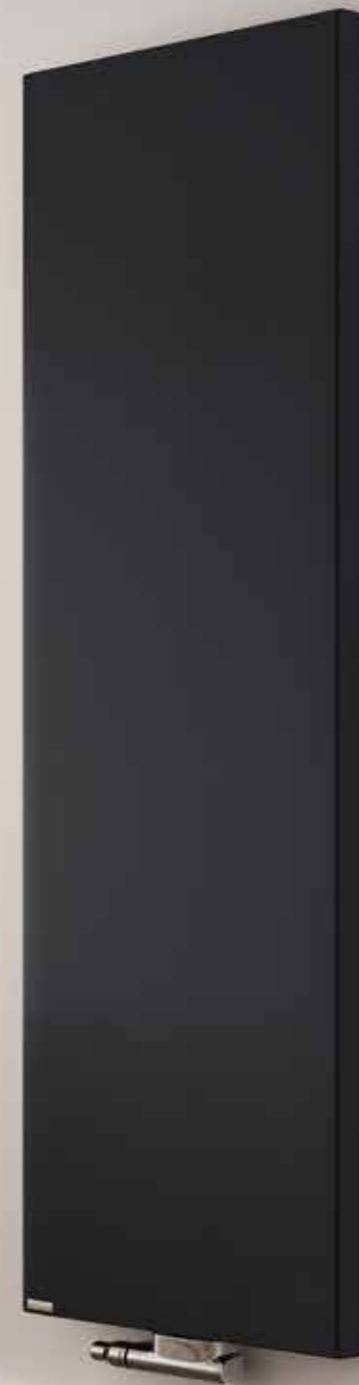



Concord Lo-Line Coloured

Conveniently designed to squeeze into small spaces in your home, the Stelrad Home Series Concord Lo-Line Coloured has it all.

800mm - 2200mm

148mm - 296mm

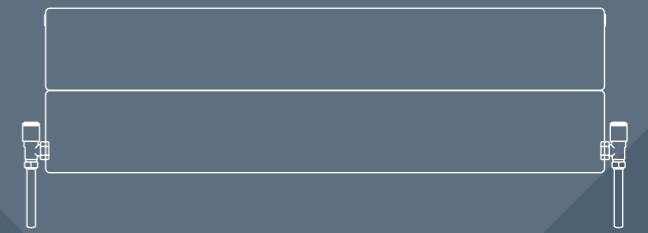

Pastel green



Colour options available.
See pages 12 & 13.

Concord Plane

The Stelrad Home Series Concord Plane offers a contemporary, modern way to heat your room.

500mm - 3000mm

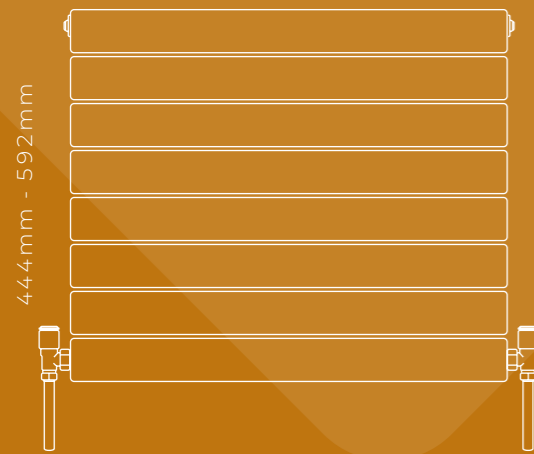

Only available
in Traffic White



5
YEAR
WARRANTY



IN STOCK





Concord Plane Coloured

Available in an abundance of colour options the Stelrad Home Series Concord Plane Coloured gives you the ability to amplify your home with whatever colour palette you choose.

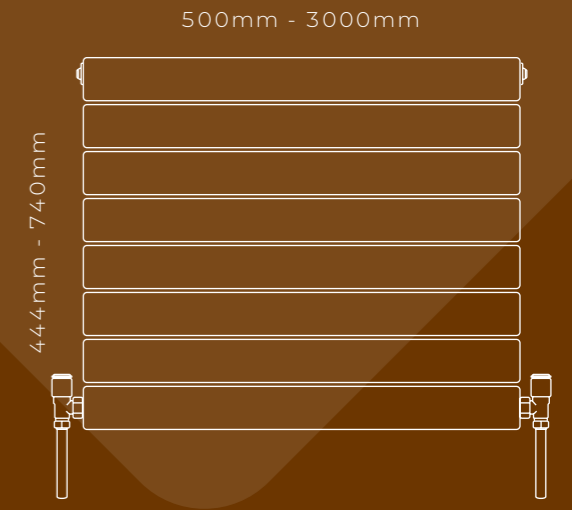

Golden yellow

Colour options available.
See pages 12 & 13.

Concord Vertical

The Stelrad Home Series Concord Vertical is visually appealing and constructed from slim, flat tubes.

444mm - 740mm

1800mm - 2000mm

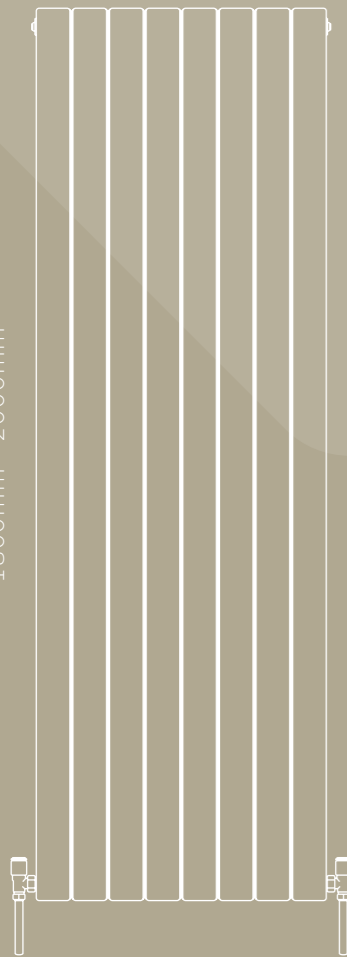

Only available
in Traffic White



5
YEAR
WARRANTY



IN STOCK

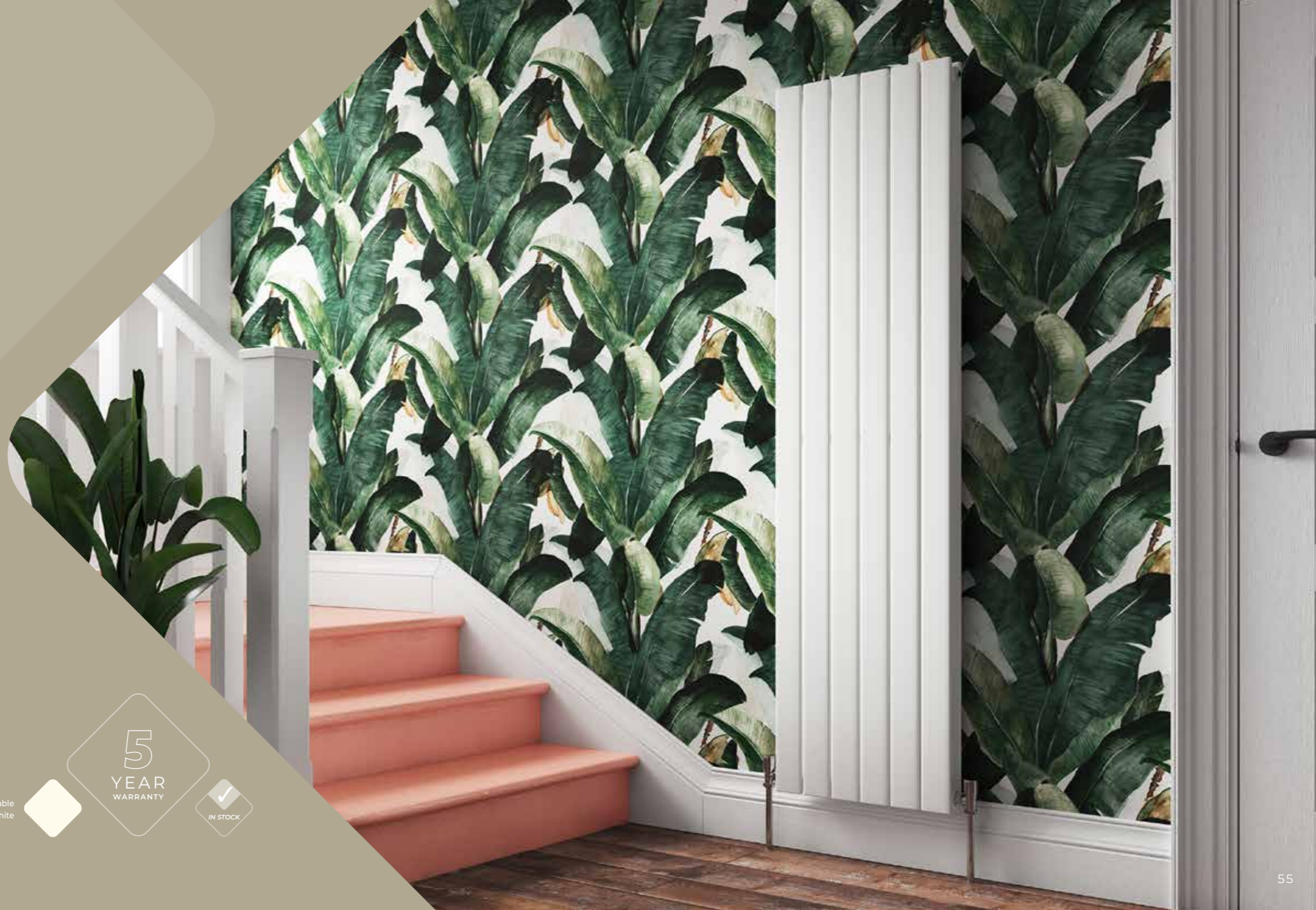



Concord Vertical Concept

The Stelrad Home Series Concord Vertical Concept in Anthracite grey shows off the slim, flat tubes of this beautiful radiator.

444 mm - 740 mm



Only available in Anthracite grey

Concord Vertical Coloured

Offering an array of over 30 colour options, the Stelrad Home Series Concord Vertical Coloured can be suited to any décor.

444mm - 740mm

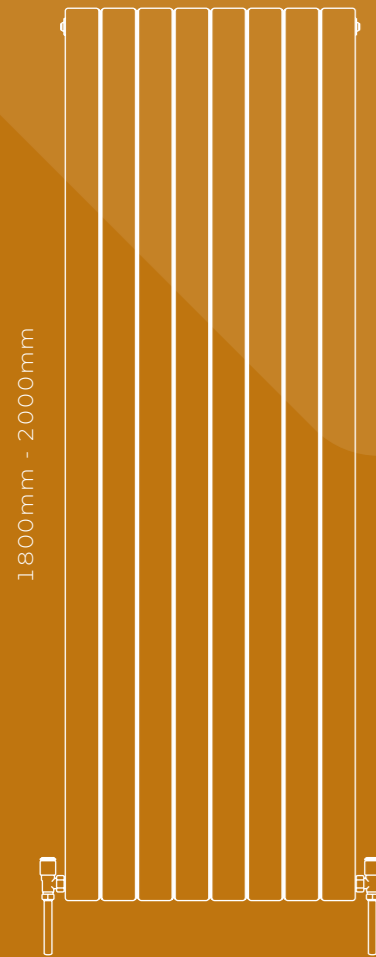

Colour options available.
See pages 12 & 13.



Golden yellow



Concord Chrome Vertical

The Stelrad Home Series Concord Chrome Vertical is a stunning, minimalist vertical flat panel designer radiator in a modern, eye-catching mirror Chrome finish.

310mm - 604mm

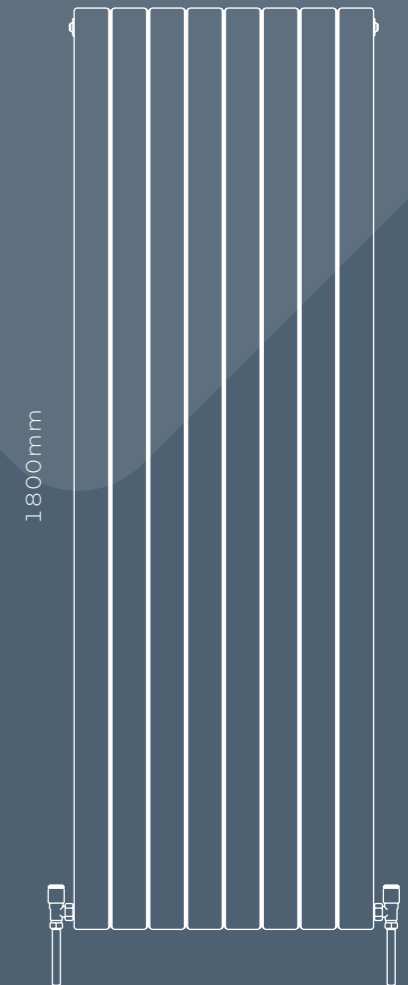

1800mm



5
YEAR
WARRANTY



Only available
in Chrome

Concord Slimline

The Stelrad Home Series Concord Slimline radiator is fashionable, with slim vertical flat panel tubing to maximise the space in your room.

320mm - 640mm

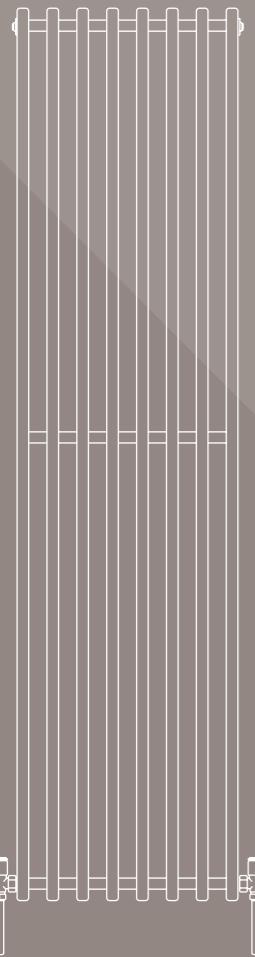

Only available
in Traffic White



5
YEAR
WARRANTY



IN STOCK





Concord Slimline Concept

The Stelrad Home Series Concord Slimline Concept radiator in Anthracite grey makes a statement and maximises space in your room, without compromising on output.

320mm - 640mm

1800mm

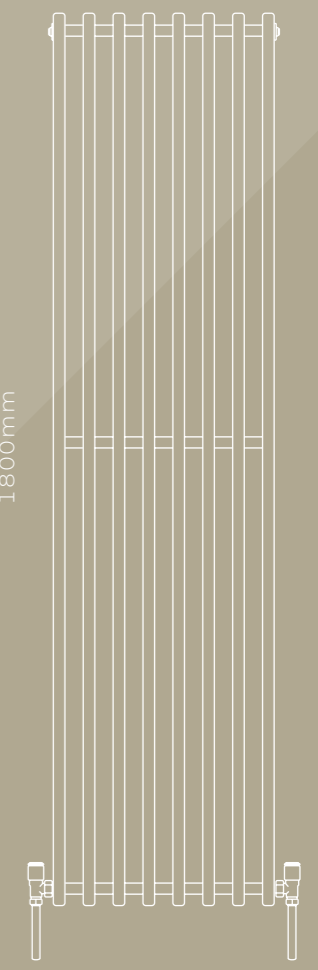

 IN STOCK

5
YEAR
WARRANTY

 Only available
in Anthracite grey

Concord Slimline Coloured

The slim and stylish tubed design of the Stelrad Home Series Concord Slimline Coloured is available in over 30 colours.

320mm - 640mm

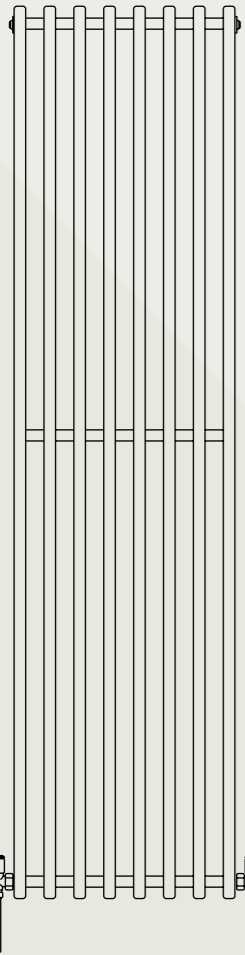

1800mm - 2000mm

Colour options available.
See pages 12 & 13.



Pastel blue



Column Horizontal

The Stelrad Home Series Column Horizontal is perfectly designed for all interiors whether it's contemporary or traditional.

444mm - 1870mm

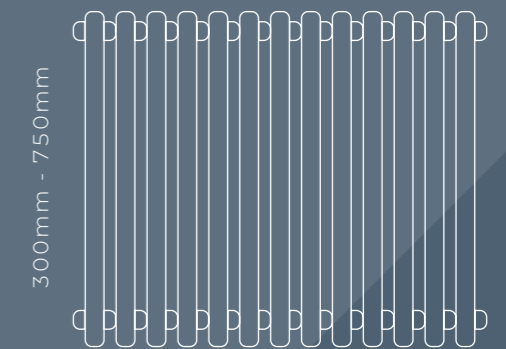

5
YEAR
WARRANTY



Only available
in Traffic White

Column Concept

Add a little colour to your home with the Stelrad Home Series Column Concept in Anthracite grey, the ultra-modern version of the retro Column radiator.

628mm - 1272mm

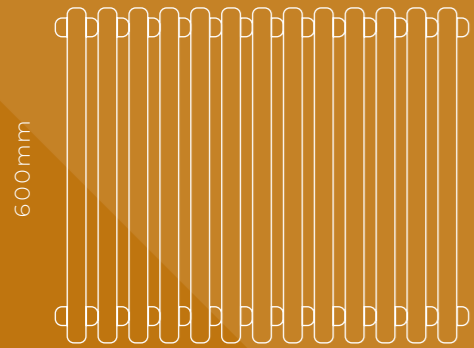

Only available
in Anthracite grey



5
YEAR
WARRANTY





Column Horizontal Coloured

The Stelrad Home Series Column Horizontal Coloured has colour options to harmonise with the boldest or most neutral of decors.

444mm - 1870mm

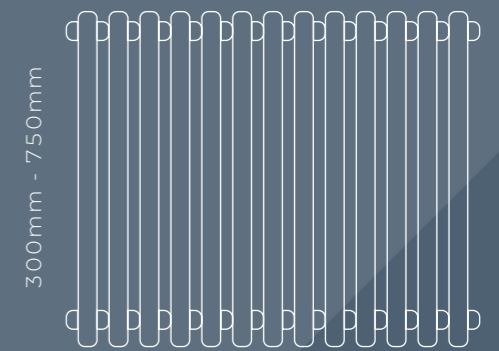

Turquoise blue



Colour options available.
See pages 12 & 13.

Column Vertical

The Stelrad Home Series Column Vertical provides a real style statement. Ideal for use in modern, minimalist rooms or where wall space is restricted.

352mm - 444mm

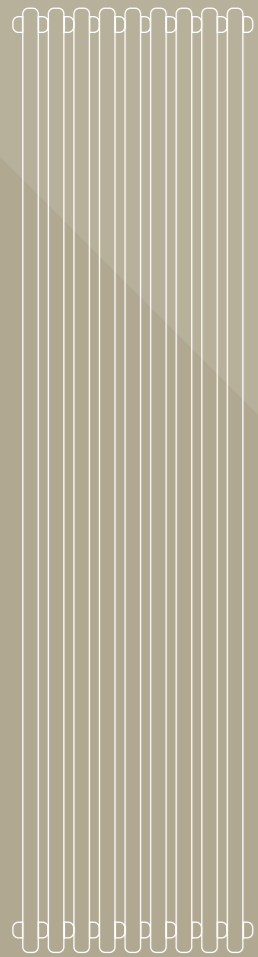

1800mm - 2500mm

Only available
in Traffic White



5
YEAR
WARRANTY



IN STOCK





Column Vertical Concept

The Stelrad Home Series Column Vertical Concept is a contemporary twist on the retro column radiator. Make a bold statement in your room with this Anthracite grey vertical column.

444mm

1800mm - 2000mm

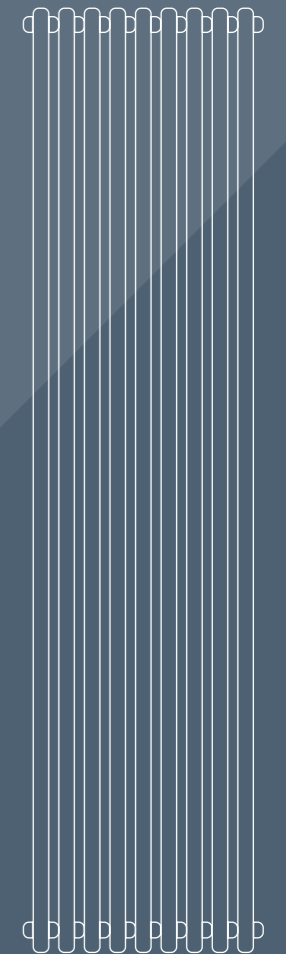

Only available
in Anthracite grey

Column Vertical Coloured

Offering a chic solution that can accentuate the use of traditional materials and enhance a contemporary or period appearance, the Stelrad Home Series Column Vertical Coloured is the perfect choice.

352mm - 444mm

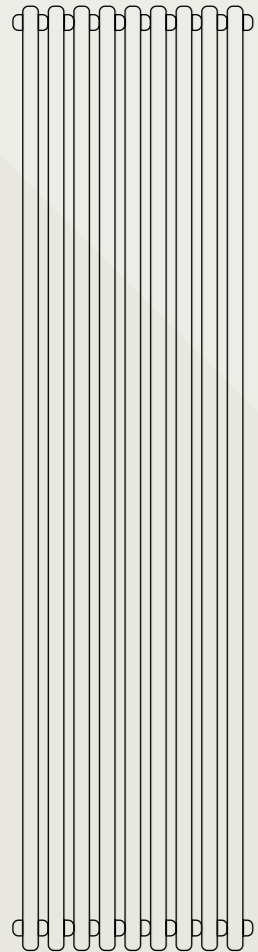

1800mm - 2500mm

Colour options available.
See pages 12 & 13.



Bronze metallic





Cast Iron Column

The stylish Home Series Cast Iron Column radiator has the classic clean lines of a column. Its elegant design means that it is a popular choice and well suited for either a modern or period home setting.

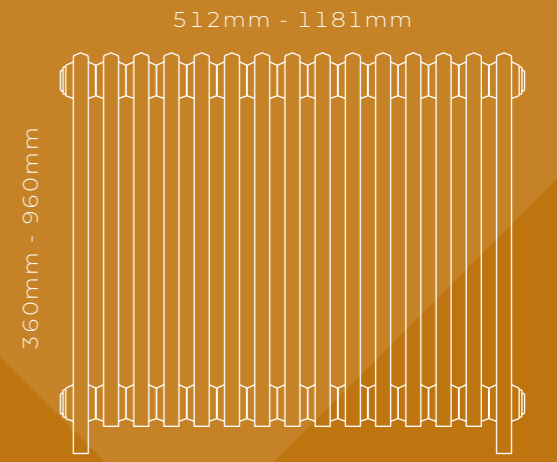

 **10**
YEAR
WARRANTY



Available in Aged Gold, Anthracite Black, Bright Gold, Bronze, Copper, Natural Cast, Old Penny, Old Pewter, Pewter and Sovereign Gold

LST Standard Horizontal Line

The Stelrad Home Series LST Standard Horizontal Line radiators are the Low Surface Temperature safe heating option for your home.

560mm - 1960mm

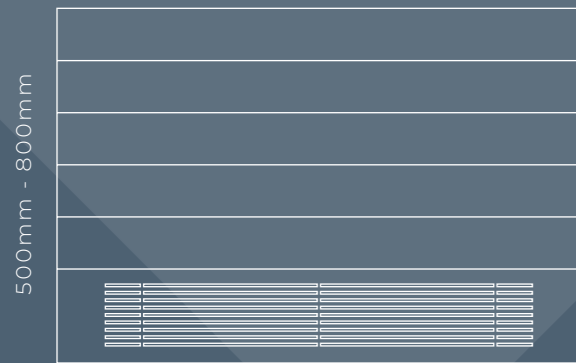

10
YEAR
WARRANTY
(EMITTER)

5
YEAR
WARRANTY
(CASING)

MADE TO ORDER

SAFE TO TOUCH

Only available in Traffic White



LST i Plus Horizontal Line

The Stelrad Home Series LST i Plus Horizontal Line is a safety must have. Offering high heat output but safe to touch, with an aesthetically pleasing lined front.

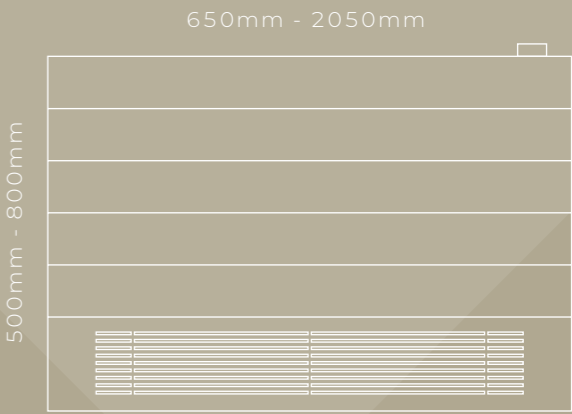

10
YEAR
WARRANTY
(EMITTER)

5
YEAR
WARRANTY
(CASING)

MADE TO
ORDER

SAFE TO
TOUCH



Only available
in Traffic White

Heavy Duty Deco

The Stelrad Heavy Duty Deco radiator combines sleek design with durability, featuring a robust steel fascia and high heat output, ideal for demanding environments.



Only available
in Traffic White



5
YEAR
WARRANTY



MADE TO
ORDER





Heavy Duty Planar

The Heavy Duty Planar radiator combines sleek, flat-fronted design with a robust 2mm steel fascia, perfect for busy commercial spaces.

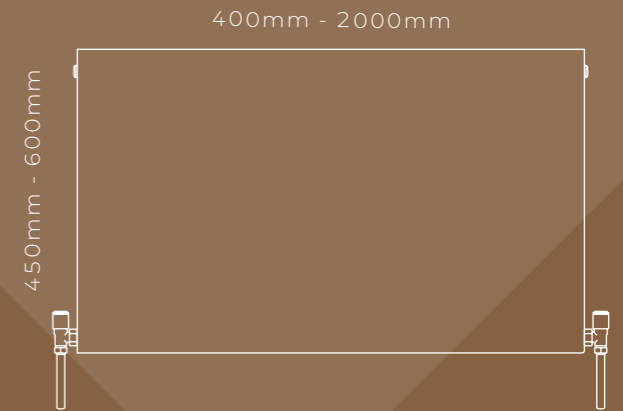

Only available
in Traffic White

MAKING A STATEMENT WITH COLOUR

One of the most impactful ways to make a statement is with colour... and it is so on trend. Whether it's a hint of colour or a bold statement with a lot of colour, this is one of the most versatile ways of reflecting your personality and setting the mood you desire.

Ultra in Pale blue

The bespoke Ultra is a modern designer radiator with optional towel rail bars, which comes in a whole range of colours - see page 116.



Concord Side Concept

Comes in a matt finish Anthracite grey and is a flat tubular design with piping at one side giving a sleek, stylish look to any room - see page 112.

Beautiful Cast Iron Column

Available in Natural Cast. See page 80.



Look out for these colour swatches on the product pages and view the colour chart on pages 12-13.

Concord Rail in Carmine Red

See page 108.



Your radiator can bring that pop of colour that you're looking for and can look stunning on a white background or the same coloured accent wall.

Bathroom Towel Radiator - Curved

The curved version of the Stelrad Home Series Classic Towel Rail provides effective heating and practical drying performance for any kitchen or bathroom. It benefits from 25mm round tubes for a higher heat output.

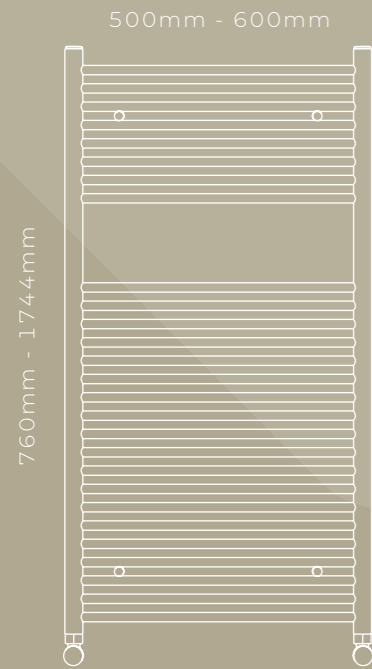

Only available in
Traffic White or Chrome



5
YEAR
WARRANTY





Bathroom Towel Radiator - Straight

The straight version of the Stelrad Home Series Classic Towel Rail provides effective heating and practical drying performance for any kitchen or bathroom. It benefits from 25mm round tubes for a higher heat output.

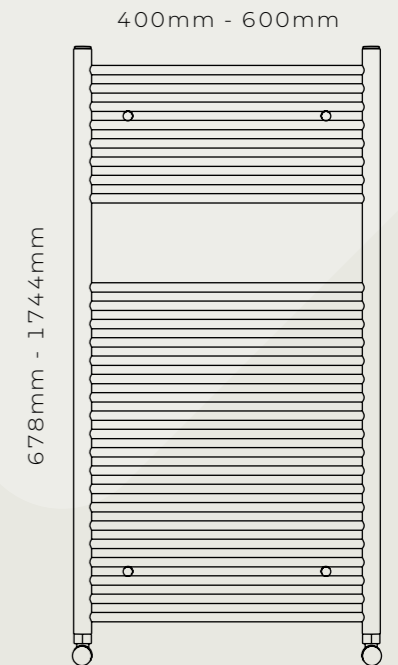

Mini Bathroom Towel Radiator size 678mm x 400mm



Only available in
Traffic White or Chrome

SMALL ON SPACE, BIG ON STYLE

Nowadays there are so many ways to make the most of small spaces. Clever storage options and smart finishes mean that even the smallest of bathrooms or kitchens can be stylish as well as practical. Whether you opt for a sleek streamlined look, or traditional detailing, there are plenty of ways to make your space stylish, practical and, with the right know-how, space efficient.

Concord Rail

This radiator not only warms your towels but also looks great in a bathroom.

See page 108.



Como.
See page 102.



Concord Slimline

Sometimes a narrow space fits a thinner vertical rail better.

See page 62.

Concord Lo-Line Coloured

See page 48.



Stainless Steel Towel Rail with polished steel finish.
See page 100.



Mini Bathroom Towel Radiator

with 25mm tubes for high heat output, see page 94.





Matte Black Towel Rail

Beautiful and functional, the matte black towel rail from the Home Series adds a striking focal point to your bathroom while serving as a practical radiator.

420mm - 500mm

700mm - 1211mm

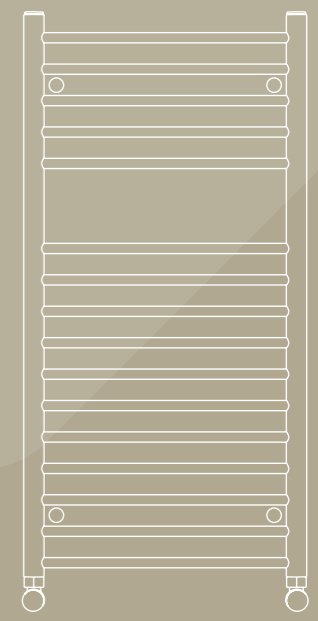

Only available in Matte Black

Stainless Steel Towel Rail

The Stelrad Home Series Stainless Steel Towel Rail in its brushed or polished finish, not only warms your towels but also looks great in a kitchen or bathroom.

500mm - 600mm

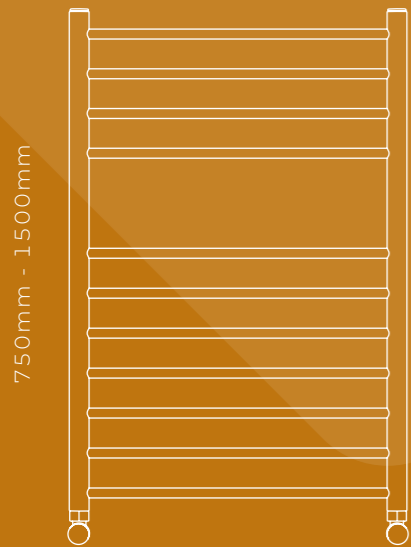

A Brushed or Polished finish looks great in the kitchen or bathroom



Available in Brushed Stainless Steel or Polished Stainless Steel



5
YEAR
WARRANTY



IN STOCK

Brushed steel



Como

The Stelrad Home Series Como is a stylish towel rail with flat brushed stainless-steel rectangular tubes to create a modern, contemporary look in any bathroom or kitchen.

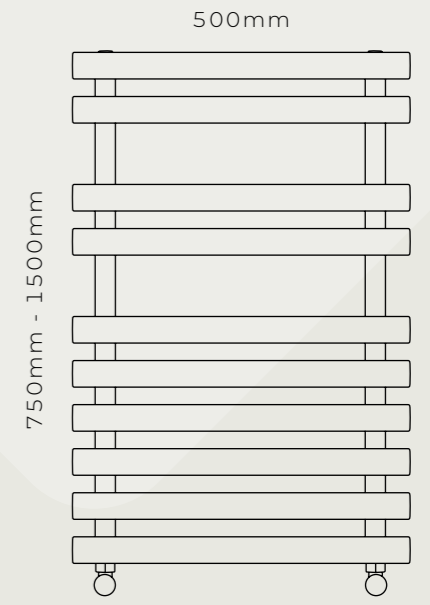

 IN STOCK

5
YEAR
WARRANTY

 Only available in
Brushed Stainless Steel

Caliente Rail

The Stelrad Home Series Caliente Rail is a hugely popular tubular option, it's an easy choice for any bathroom or kitchen and any interior setting whether it's a modern, contemporary or period interior. It benefits from 22mm round tubes for a higher heat output.

450mm - 750mm

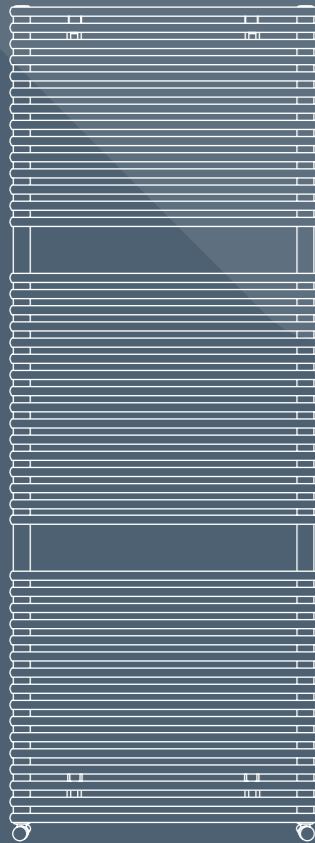

755mm - 2013mm

Colour options available.
(Made to Order)
See pages 12 & 13.



5
YEAR
WARRANTY



TRAFFIC WHITE



Your radiator can bring that pop of colour that you're looking for



Ultramarine blue

MARVELLOUS METALLICS

Get involved with the trend that is taking the world by storm; metallic finishes. From chrome to brass, stainless steel to copper and everything in between, you can't hide from these finishes adorning the pages of your favourite interior magazines. The high shine surface of chrome exudes luxury and is suited to all home decor styles, especially modern interiors.



Bathroom Towel Radiator - Straight

with 25mm tubes for high heat output, see page 94.

Exclusive to Stelrad Group plc

Lecco
A stunning combination of brushed and polished steel finishes. See page 114.



Concord Side Chrome

Oozes functionality and style with its stunning chrome finish. See page 110.

Metallics are super hardwearing and perfect for busy family life, whilst remaining stylish and eye-catching.

Concord Chrome Vertical

See page 60.



Concord Rail

The Stelrad Home Series Concord Rail offers a stunning alternative to tubular towel rails with flat tube on tube and will enhance any kitchen or bathroom. Available in a range of colours making it simple to match and contrast colour schemes.

450mm - 600mm

731mm - 1771mm

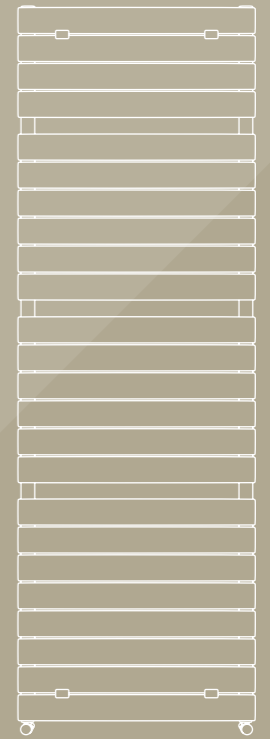

TRAFFIC WHITE



Colour options available.
(Made to Order)
See pages 12 & 13.

Concord Side Chrome

The Stelrad Concord Side Chrome oozes functionality and style with its stunning chrome finish. Gone are the days when towel rails were merely a heating device, they are now a design feature too.

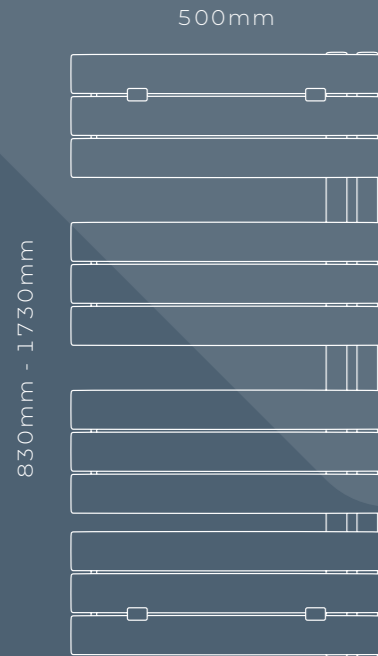

Exude luxury with high shine chrome

Only available in Chrome

5 YEAR WARRANTY

IN STOCK



Concord Side Concept

The Stelrad Concord Side Concept radiator in a matt finish Anthracite grey is a straight tubular design with piping at one side giving a sleek, stylish look to any room.

500mm

830mm - 1730mm

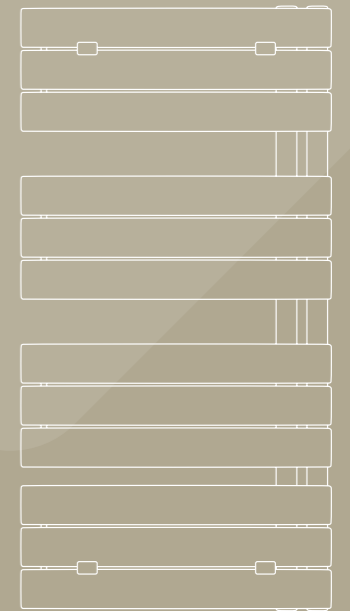

Only available
in Anthracite grey

Lecco

Exclusive
to Stelrad
Group plc

The exclusive Stelrad Home Series Lecco Towel Rail adds a designer touch of luxury to your room with its stunning combination of brushed and polished steel finishes.

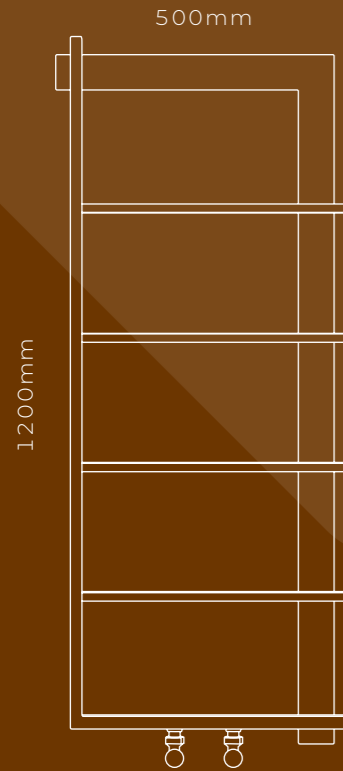

Polished finish

Brushed finish

Only available in
Brushed & Polished Steel



5
YEAR
WARRANTY



IN STOCK



Ultra

The bespoke Stelrad Home Series Ultra is a modern designer radiator with optional towel rails, making it perfectly suited to bathrooms and kitchens.



Please refer to page 156 for more information on the optional towel rail bar (only one per radiator) and the bar sizes.

MADE TO ORDER

10 YEAR WARRANTY

Colour options available. See pages 12 & 13.

Carmine Red

Vertical Ultra

The Stelrad Home Series Vertical Ultra radiator is as unique as you are with the option of one or two towel rails and can be tailored to suit any bathroom or kitchen.

470mm - 670mm

1040mm - 2040mm

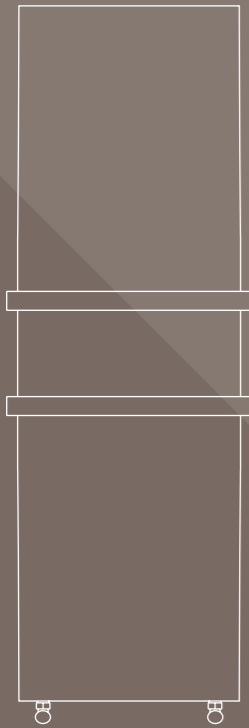

Please refer to page 156 for more information on the optional towel rail bars (up to 3) and the bar sizes.

Colour options available. See pages 12 & 13.



Mocha

SIZES, HEATING SPECIFICATIONS AND ACCESSORIES

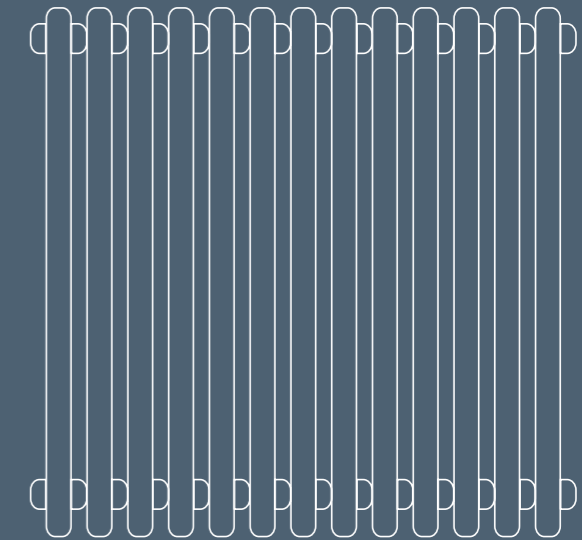
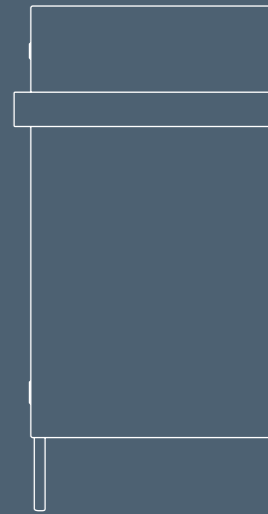
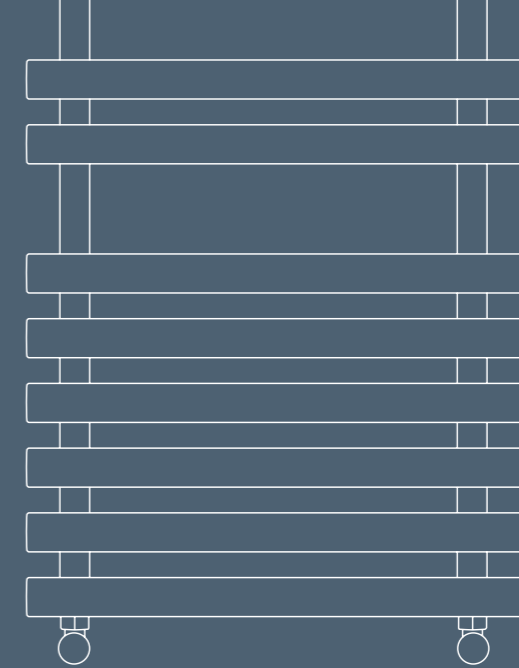
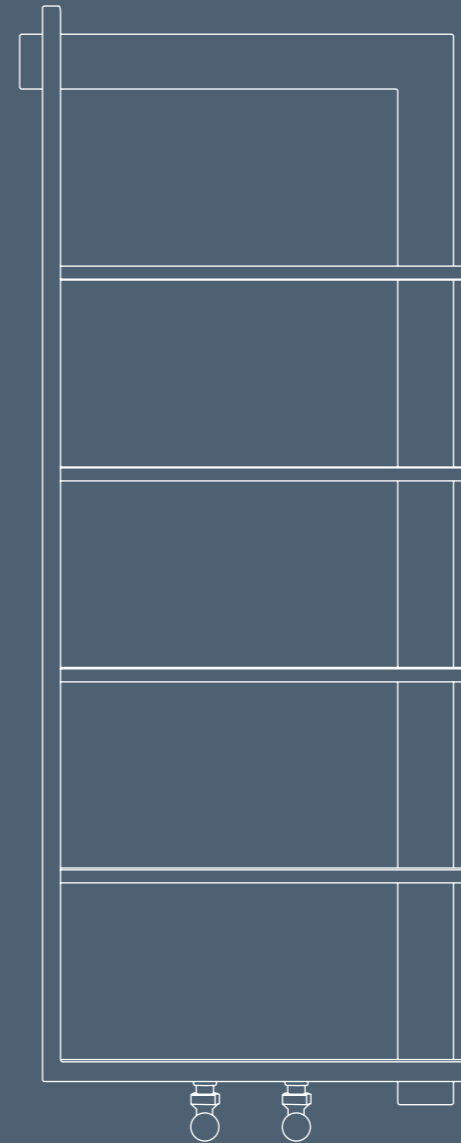
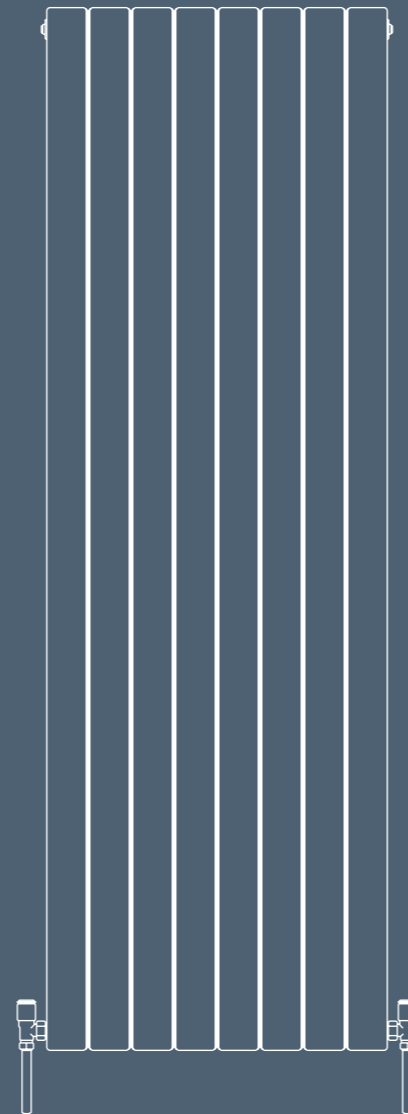
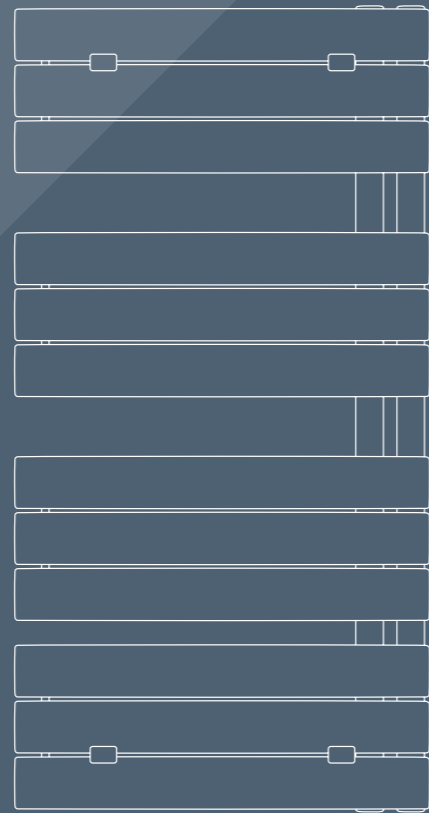
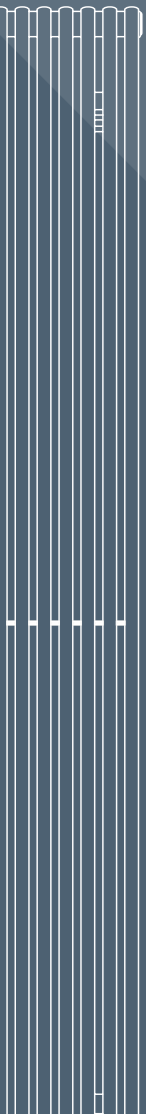

Δt_{50} is the UK's industry standard for heating outputs, which has an operating temperature of 75/65/20°C. If you have a low temperature heat source you may wish to consider Δt_{40} or Δt_{30} output (see your installer or system designer or download from www.stelrad.com).

For EN442 data, technical and installation information please visit our website: www.stelrad.com and search under advice and then downloads.

SIZES AND HEATING SPECIFICATIONS

CLASSIC COMPACT

50Δt
(75/65/20°C)



Height mm	Length mm	K1		P+			K2		
		Stelrad UIN	Heat output Watts Btu/hr	Stelrad UIN	Heat output Watts Btu/hr	Stelrad UIN	Heat output Watts Btu/hr	Stelrad UIN	Heat output Watts Btu/hr
300	400	143899h	204 696	- - -	- - -	- - -	- - -	- - -	
	500	931105h	254 866	932105h	373 1,273	932205h	490 1,674		
	1000	931110h	508 1,734	932110h	745 2,543	932210h	981 3,349		
	1500	931115h	762 2,601	932115h	1,118 3,816	932215h	1,472 5,023		
	2000	143653h	1,018 3,474	143659h	1,490 5,085	932220h	1,962 6,698		
	2500	143654h	1,273 4,345	143660h	1,863 6,358	143666h	2,455 8,379		
	3000	143655h	1,527 5,212	143661h	2,235 7,628	143667h	2,946 10,055		
	450	400	941104h	302 1,032	143698h	422 1,440	942204h	548 1,871	
500		941105h	378 1,290	942105h	528 1,801	942205h	685 2,339		
600		941106h	454 1,548	942106h	633 2,161	942206h	822 2,807		
700		941107h	529 1,806	942107h	739 2,522	942207h	959 3,274		
800		941108h	605 2,064	942108h	844 2,882	942208h	1,096 3,742		
900		941109h	680 2,322	942109h	950 3,242	942209h	1,234 4,210		
1000		941110h	756 2,579	942110h	1,055 3,602	942210h	1,371 4,678		
1100		941111h	831 2,837	942111h	1,161 3,962	942211h	1,508 5,146		
1200		941112h	907 3,095	942112h	1,267 4,323	942212h	1,645 5,613		
1400		941114h	1,058 3,611	942114h	1,478 5,044	942214h	1,919 6,549		
1600		941116h	1,209 4,127	942116h	1,689 5,764	942216h	2,193 7,485		
1800		941118h	1,360 4,643	942118h	1,900 6,485	942218h	2,467 8,420		
2000		941120h	1,512 5,159	942120h	2,111 7,205	942220h	2,742 9,358		
2200		941122h	1,603 5,470	143711h	2,321 7,922	942222h	3,016 10,294		
2400		941124h	1,814 6,190	143712h	2,532 8,642	942224h	3,290 11,230		
2600		143695h	1,966 6,710	143713h	2,743 9,362	143731h	3,565 12,167		
2800		143696h	2,117 7,225	143714h	2,954 10,082	143732h	3,839 13,103		
3000	143697h	2,268 7,741	143715h	3,165 10,802	143733h	4,113 14,038			

CLASSIC COMPACT (CONTINUED)

50Δt
(75/65/20°C)



Height mm	Length mm	K1		P+			K2		
		Stelrad UIN	Heat output Watts Btu/hr	Stelrad UIN	Heat output Watts Btu/hr	Stelrad UIN	Heat output Watts Btu/hr	Stelrad UIN	Heat output Watts Btu/hr
600	300	143646h	294 1,003	- - -	962204h	520 1,774			
	400	961104h	392 1,338	962104h	539 1,838	962204h	693 2,364		
	500	961105h	490 1,672	962105h	673 2,298	962205h	866 2,955		
	600	961106h	588 2,006	962106h	808 2,758	962206h	1,039 3,546		
	700	961107h	686 2,341	962107h	943 3,217	962207h	1,212 4,137		
	800	961108h	784 2,675	962108h	1,077 3,677	962208h	1,385 4,728		
	900	961109h	882 3,009	962109h	1,212 4,137	962209h	1,558 5,319		
	1000	961110h	980 3,344	962110h	1,347 4,597	962210h	1,732 5,910		
	1100	961111h	1,078 3,678	962111h	1,481 5,056	962211h	1,905 6,501		
	1200	961112h	1,176 4,013	962112h	1,616 5,516	962212h	2,078 7,092		
	1400	961114h	1,372 4,681	962114h	1,885 6,435	962214h	2,424 8,273		
	1600	961116h	1,568 5,350	962116h	2,155 7,354	962216h	2,770 9,455		
	1800	961118h	1,764 6,019	962118h	2,424 8,273	962218h	3,117 10,637		
	2000	961120h	2,234 7,623	962120h	2,694 9,193	962220h	3,466 11,831		
	2200	961122h	2,156 7,357	143777h	2,959 10,099	962222h	3,813 13,014		
	2400	961124h	2,352 8,025	143778h	3,228 11,017	962224h	4,160 14,197		
	2600	143761h	2,548 8,696	143779h	3,497 11,935	143797h	4,503 15,369		
2800	143762h	2,744 9,365	143780h	3,766 12,853	143798h	4,850 16,553			
3000	143763h	2,940 10,034	143781h	4,035 13,771	143799h	5,196 17,734			
700	300	143648h	335 1,143	972104h	613 2,092	143649h	588 2,006		
	400	971104h	447 1,524	972104h	613 2,092	972204h	784 2,676		
	500	971105h	558 1,906	972105h	766 2,614	972205h	980 3,345		
	600	971106h	670 2,287	972106h	919 3,137	972206h	1,176 4,015		
	700	971107h	782 2,668	972107h	1,072 3,660	972207h	1,372 4,684		
	800	971108h	893 3,049	972108h	1,226 4,183	972208h	1,568 5,353		
	900	971109h	1,005 3,430	972109h	1,379 4,706	972209h	1,764 6,022		
	1000	971110h	1,117 3,811	972110h	1,532 5,228	972210h	1,960 6,691		
	1100	971111h	1,228 4,192	972111h	1,685 5,752	972211h	2,156 7,360		
	1200	971112h	1,340 4,573	972112h	1,839 6,275	972212h	2,352 8,029		
	1400	971114h	1,563 5,336	972114h	2,145 7,320	972214h	2,745 9,367		
	1600	971116h	1,787 6,098	143840h	2,448 8,355	972216h	3,137 10,705		
	1800	971118h	2,010 6,860	143841h	2,754 9,399	972218h	3,529 12,044		
	2000	971120h	2,234 7,623	143842h	3,060 10,444	972220h	3,927 13,404		
	2200	143825h	2,457 8,386	143843h	3,366 11,488	143861h	4,314 14,724		
	2400	143826h	2,681 9,150	143844h	3,672 12,533	143862h	4,706 16,062		
	2600	143827h	2,904 9,911	143845h	3,978 13,577	143863h	5,099 17,403		
2800	143828h	3,128 10,676	143846h	4,284 14,621	143864h	5,491 18,741			
3000	143829h	3,351 11,437	143847h	4,590 15,666	143865h	5,883 20,079			

SIZES AND HEATING SPECIFICATIONS

CLASSIC COMPACT 900



50Δt
(75/65/20°C)

Height mm	Length mm	K1		K2			
		Stelrad UIN	Heat output Watts	Btu/hr	Stelrad UIN	Heat output Watts	Btu/hr
900	400	3091104h	544	1,856	3092204h	958	3,269
	500	3091105h	680	2,320	3092205h	1,198	4,088
	600	3091106h	816	2,784	3092206h	1,437	4,903
	700	3091107h	952	3,248	3092207h	1,677	5,722
	800	3091108h	1,088	3,712	3092208h	1,916	6,537
	900	3091109h	1,224	4,176	3092209h	2,156	7,356
	1000	3091110h	1,360	4,640	3092210h	2,395	8,172

CLASSIC COMPACT K3



50Δt
(75/65/20°C)

Height mm	Length mm	K3		
		Stelrad UIN	Heat output Watts	Btu/hr
300	1000	76303310h	1,349	4,603
	2000	76303320h	2,698	9,206
500	600	76503306h	1,234	4,210
	700	76503307h	1,439	4,910
	800	76503308h	1,645	5,613
	900	76503309h	1,850	6,312
	1000	76503310h	2,056	7,015
	1100	76503311h	2,262	7,718
	1200	76503312h	2,467	8,417
	1400	76503314h	2,878	9,820
	1600	76503316h	3,290	11,225
	1800	76503318h	3,701	12,628
	2000	76503320h	4,112	14,030
	2400	76503324h	4,934	16,835
600	400	76603304	956	3,262
	500	76603305	1,195	4,077
	600	76603306	1,433	4,889
	700	76603307	1,672	5,705
	800	76603308	1,911	6,520
	900	76603309	2,150	7,336
	1000	76603310	2,389	8,151
	1100	76603311	2,628	8,967
	1200	76603312	2,867	9,782
	1400	76603314	3,345	11,413
	1600	76603316	3,822	13,041
	1800	76603318	4,300	14,672
2000	76603320	4,778	16,303	
2400	76603324	5,734	19,564	
700	500	76703305h	1,356	4,627
	600	76703306h	1,627	5,551
	700	76703307h	1,898	6,476
	800	76703308h	2,170	7,404
	900	76703309h	2,441	8,329
	1000	76703310h	2,712	9,253
	1100	76703311h	2,983	10,178
	1200	76703312h	3,254	11,103
	1400	76703314h	3,797	12,955
	1600	76703316h	4,339	14,805
	1800	76703318h	4,882	16,657
	2000	76703320h	5,424	18,507

SIZES AND HEATING SPECIFICATIONS

CLASSIC COMPACT XTRA PROTECTION



50Δt
(75/65/20°C)

Height mm	Length mm	Stelrad UIN	K1	
			Watts	Heat output Btu/hr
450	400	144850h	302	1,031
	600	144851h	454	1,550
	800	144852h	605	2,065
	1000	144853h	756	2,580
600	400	144854h	392	1,338
	600	144855h	588	2,007
	800	144856h	784	2,676
	1000	144857h	980	3,345

Height mm	Length mm	Stelrad UIN	K2	
			Watts	Heat output Btu/hr
450	400	144858h	548	1,870
	600	144859h	823	2,809
	800	144860h	1,097	3,744
	1000	144861h	1,371	4,679
	1200	144867h	1,645	5,614
	1400	144868h	1,919	6,550
	1600	144869h	2,194	7,488
	1800	144870h	2,468	8,423
600	400	144862h	693	2,365
	600	144863h	1,039	3,546
	800	144864h	1,386	4,730
	1000	144865h	1,732	5,911
	1200	144871h	2,078	7,092
	1400	144872h	2,425	8,277
	1600	144873h	2,771	9,457
	1800	144874h	3,118	10,642

CLASSIC COMPACT VERTICAL



50Δt
(75/65/20°C)

Height mm	Length mm	Stelrad UIN	P2		K2	
			Watts	Heat output Btu/h	Stelrad UIN	Heat output Watts Btu/h
1600	300	-	-	-	31162203h	1,089 3,716
	400	-	-	-	31162204h	1,452 4,954
	500	-	-	-	31162205h	1,815 6,193
	600	-	-	-	31162206h	2,178 7,432
1800	300	-	-	-	31182203h	1,188 4,054
	400	148095h	1,146	3,911	89121418h	1,584 5,405
	500	-	-	-	89122518h	1,980 6,756
	600	148103h	1,719	5,867	89122618h	2,376 8,107
	700	148107h	2,006	6,846	31182207h	2,772 9,458
2000	400	148096h	1,248	4,259	31202204h	1,716 5,855
	500	-	-	-	31202205h	2145 7319
	600	148104h	1,872	6,389	31202206h	2,574 8,782
	700	148108h	2,184	7,454	31202207h	3,003 10,246
2200	300	-	-	-	31222203h	1,386 4,729
	400	148097h	1,356	4,628	31222204h	1,848 6,305
	500	-	-	-	31222205h	2,310 7,882
	600	148105h	2,034	6,942	31222206h	2,772 9,458
	700	148109h	2,373	8,099	-	- -
	-	-	-	-	-	- -



We recommend a Centre Tap TRV to complete the look.
See page 157 for more information.

SIZES AND HEATING SPECIFICATIONS

COMPACT VERTICAL LINE VERTICAL



50Δt
(75/65/20°C)

Height mm	Length mm	K1		K2			
		Stelrad UIN	Heat output Watts	Heat output Btu/h	Stelrad UIN	Heat output Watts	Heat output Btu/h
300	500	92301105h	235	802	92302205h	449	1,532
	1000	92301110h	470	1,604	92302210h	898	3,064
	1500	92301115h	705	2,405	92302215h	1,347	4,596
450	400	92451104h	272	928	92452204h	509	1,737
	600	92451106h	409	1,396	92452206h	764	2,607
	700	92451107h	477	1,628	92452207h	891	3,040
	800	92451108h	545	1,860	92452208h	1,018	3,473
	900	92451109h	613	2,092	92452209h	1,145	3,909
	1000	92451110h	681	2,324	92452210h	1,273	4,343
	1100	92451111h	749	2,556	92452211h	1,400	4,779
	1200	92451112h	817	2,788	92452212h	1,528	5,214
	1400	92451114h	953	3,252	92452214h	1,782	6,080
	1600	92451116h	1,090	3,719	92452216h	2,037	6,950
600	1800	92451118h	1,226	4,183	92452218h	2,291	7,817
	400	92601104h	348	1,187	92602204h	640	2,184
	600	92601106h	522	1,781	92602206h	961	3,279
	700	92601107h	609	2,078	92602207h	1,121	3,825
	800	92601108h	696	2,375	92602208h	1,281	4,371
	900	92601109h	783	2,672	92602209h	1,441	4,917
	1000	92601110h	870	2,968	92602210h	1,601	5,463
	1100	92601111h	957	3,265	92602211h	1,761	6,009
	1200	92601112h	957	3,265	92602212h	1,921	6,554
	1400	92601114h	1,218	4,156	92602214h	2,241	7,646
1600	92601116h	1,392	4,750	92602216h	2,562	8,742	
1800	92601118h	1,566	5,343	92602218h	2,882	9,833	
2000	92601120h	1,740	5,937	92602220h	3,202	10,925	

COMPACT VERTICAL LINE VERTICAL



50Δt
(75/65/20°C)

Height mm	Length mm	K2		
		Stelrad UIN	Heat output Watts	Heat output Btu/hr
1800	400	89222418h	1,476	5,036
	500	89222518h	1,845	6,295
	600	89222618h	2,214	7,554

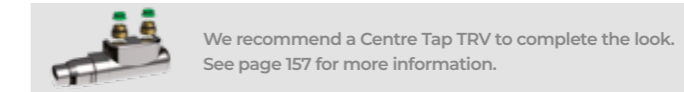

We recommend a Centre Tap TRV to complete the look. See page 157 for more information.

COMPACT VERTICAL LINE CONCEPT



50Δt
(75/65/20°C)

Height mm	Length mm	K1		K2			
		Stelrad UIN	Heat output Watts	Heat output Btu/h	Stelrad UIN	Heat output Watts	Heat output Btu/h
600	400	51601104h	348	1,187	51602204h	640	2,184
	600	51601106h	522	1,781	51602206h	961	3,279
	700	51601107h	609	2,078	51602207h	1,121	3,825
	800	51601108h	696	2,375	51602208h	1,281	4,371
	900	51601109h	783	2,672	51602209h	1,441	4,917
	1000	51601110h	870	2,968	51602210h	1,601	5,463
	1100	51601111h	957	3,265	51602211h	1,761	6,009
	1400	51601114h	1,218	4,156	51602214h	2,241	7,646

COMPACT VERTICAL LINE VERTICAL CONCEPT



50Δt
(75/65/20°C)

Height mm	Length mm	K2		
		Stelrad UIN	Heat output Watts	Heat output Btu/hr
1800	400	22182204h	1,476	5,036
	500	22182205h	1,845	6,295
	600	22182206h	2,214	7,554

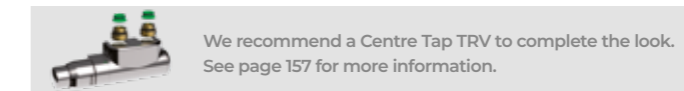

We recommend a Centre Tap TRV to complete the look. See page 157 for more information.

SIZES AND HEATING SPECIFICATIONS

COMPACT HORIZONTAL LINE



50Δt
(75/65/20°C)

Height mm	Length mm	K1		K2	
		Stelrad UIN	Heat output Watts Btu/h	Stelrad UIN	Heat output Watts Btu/h
300	500	82301105h	235 802	82302205h	449 1,532
	1000	82301110h	469 1,601	82302210h	898 3,064
	1500	82301115h	704 2,401	82302215h	1,347 4,596
450	400	82451104h	272 928	82452204h	509 1,737
	600	82451106h	409 1,396	82452206h	764 2,607
	700	82451107h	477 1,628	82452207h	891 3,040
	800	82451108h	545 1,860	82452208h	1,018 3,474
	900	82451109h	613 2,092	82452209h	1,145 3,909
	1000	82451110h	681 2,324	82452210h	1,273 4,344
	1100	82451111h	749 2,556	82452211h	1,400 4,779
	1200	82451112h	817 2,788	82452212h	1,528 5,214
	1400	82451114h	953 3,252	82452214h	1,782 6,080
	1600	82451116h	1,090 3,719	82452216h	2,037 6,951
600	1800	82451118h	1,226 4,183	82452218h	2,291 7,817
	400	82601104h	348 1,188	82602204h	640 2,184
	600	82601106h	522 1,782	82602206h	961 3,280
	700	82601107h	609 2,078	82602207h	1,121 3,825
	800	82601108h	696 2,375	82602208h	1,281 4,372
	900	82601109h	783 2,672	82602209h	1,441 4,917
	1000	82601110h	870 2,969	82602210h	1,601 5,464
	1100	82601111h	957 3,265	82602211h	1,761 6,009
	1200	82601112h	1,044 3,563	82602212h	1,921 6,556
	1400	82601114h	1,218 4,157	82602214h	2,242 7,649
	1600	82601116h	1,392 4,751	82602216h	2,563 8,744
1800	82601118h	1,566 5,345	82602218h	2,883 9,836	
2000	82601120h	1,740 5,939	82602220h	3,203 10,928	

COMPACT FLAT



50Δt
(75/65/20°C)

Height mm	Length mm	K1		K2	
		Stelrad UIN	Heat output Watts Btu/h	Stelrad UIN	Heat output Watts Btu/h
300	500	81301105h	235 802	81302205h	465 1,587
	1000	81301110h	469 1,601	81302210h	929 3,171
	1500	81301115h	704 2,401	81302215h	1,394 4,756
450	400	81451104h	280 955	81452204h	518 1,767
	600	81451106h	421 1,437	81452206h	778 2,655
	800	81451108h	561 1,914	81452208h	1,037 3,538
	1000	81451110h	701 2,392	81452210h	1,296 4,422
	1200	81451112h	841 2,870	81452212h	1,555 5,306
	1400	81451114h	981 3,347	81452214h	1,814 6,190
	1600	81451116h	1,122 3,828	81452216h	2,074 7,077
	1800	81451118h	1,262 4,306	81452218h	2,333 7,961
600	400	81601104h	364 1,242	81602204h	654 2,231
	600	81601106h	547 1,866	81602206h	980 3,344
	800	81601108h	729 2,487	81602208h	1,307 4,459
	1000	81601110h	911 3,108	81602210h	1,634 5,575
	1200	81601112h	1,093 3,729	81602212h	1,961 6,691
	1400	81601114h	1,275 4,350	81602214h	2,288 7,807
	1600	81601116h	1,458 4,975	81602216h	2,614 8,919
	1800	81601118h	1,640 5,596	81602218h	2,941 10,035
	2000	81601120h	1,822 6,217	81602220h	3,268 11,150

COMPACT HORIZONTAL LINE CONCEPT



50Δt
(75/65/20°C)

Height mm	Length mm	K1		K2	
		Stelrad UIN	Heat output Watts Btu/h	Stelrad UIN	Heat output Watts Btu/h
600	400	22601104h	348 1,187	22602204h	640 2,184
	600	22601106h	522 1,781	22602206h	961 3,279
	700	22601107h	609 2,078	22602207h	1,121 3,825
	800	22601108h	696 2,375	22602208h	1,281 4,371
	900	22601109h	783 2,672	22602209h	1,441 4,917
	1000	22601110h	870 2,968	22602210h	1,601 5,463
	1100	22601111h	957 3,265	22602211h	1,761 6,009
	1200	22601112h	1,044 3,562	22602212h	1,921 6,554
	1400	22601114h	1,218 4,156	22602214h	2,241 7,646

COMPACT FLAT CONCEPT



50Δt
(75/65/20°C)

Height mm	Length mm	K1		K2	
		Stelrad UIN	Heat output Watts Btu/h	Stelrad UIN	Heat output Watts Btu/h
600	400	21601104h	364 1,242	21602204h	654 2,231
	600	21601106h	547 1,866	21602206h	980 3,344
	800	21601108h	729 2,487	21602208h	1,307 4,459
	1000	21601110h	911 3,108	21602210h	1,634 5,575
	1200	21601112h	1,093 3,729	21602212h	1,961 6,691
	1400	21601114h	1,275 4,350	21602214h	2,288 7,807

SIZES AND HEATING SPECIFICATIONS

COMPACT FLAT VERTICAL



50Δt
(75/65/20°C)

K2

Height mm	Length mm	Sections	Stelrad UIN	Heat output	
				Watts	Btu/hr
1800	400	12	89322418h	1,476	5,036
	500	15	89322518h	1,845	6,295
	600	18	89322618h	2,214	7,554

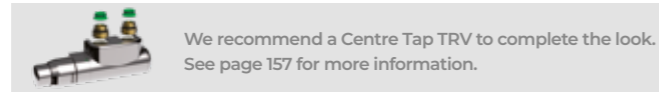

COMPACT FLAT VERTICAL CONCEPT



50Δt
(75/65/20°C)

K2

Height mm	Length mm	Stelrad UIN	Heat output	
			Watts	Btu/hr
1800	400	21182204h	1,476	5,036
	500	21182205h	1,845	6,295
	600	21182206h	2,214	7,554

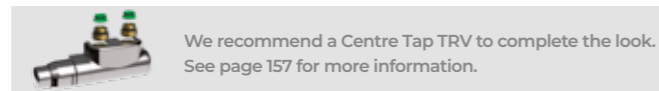

CONCORD LO-LINE COLOURED



50Δt
(75/65/20°C)

DOUBLE

Height mm	Length mm	Stelrad UIN	Heat output	
			Watts	Btu/hr
148	800	148456h	541	1,846
	1000	148457h	676	2,307
	1200	148458h	811	2,767
	1400	148459h	946	3,228
	1600	148460h	1,082	3,692
	1800	148461h	1,217	4,153
	2000	148462h	1,352	4,613
	2200	148463h	1,487	5,074
296	800	148464h	892	3,044
	1000	148465h	1,115	3,805
	1200	148466h	1,338	4,565
	1400	148467h	1,561	5,326
	1600	148468h	1,784	6,087
	1800	148469h	2,007	6,848
	2000	148470h	2,230	7,609
	2200	148471h	2,453	8,370

CONCORD PLANE



50Δt
(75/65/20°C)

SINGLE

DOUBLE

Height mm	Length mm	Stelrad UIN	Heat output		Stelrad UIN	Heat output	
			Watts	Btu/hr		Watts	Btu/hr
444	500	448346h	392	1,338	448397h	685	2,337
	600	448347h	470	1,604	448398h	821	2,801
	700	448348h	549	1,873	448399h	958	3,269
	800	448349h	627	2,139	448400h	1,095	3,736
	900	448350h	706	2,409	448401h	1,232	4,204
	1000	448351h	784	2,675	448402h	1,369	4,671
	1100	448352h	862	2,941	448403h	1,506	5,139
	1200	448353h	941	3,211	448404h	1,643	5,606
	1400	448354h	1,098	3,747	448405h	1,917	6,541
	1600	148355h	1,254	4,279	148406h	2,190	7,473
	1800	148356h	1,411	4,815	148407h	2,464	8,408
	2000	148357h	1,568	5,350	148408h	2,738	9,342
	2200	148358h	1,725	5,886	148409h	3,012	10,277
	2400	148359h	1,882	6,422	148410h	3,286	11,212
	2600	148360h	2,038	6,954	148411h	3,559	12,144
	2800	148361h	2,195	7,490	148412h	3,833	13,079
3000	148362h	2,352	8,025	148413h	4,107	14,014	

SIZES AND HEATING SPECIFICATIONS

CONCORD PLANE (CONTINUED)



50Δt
(75/65/20°C)

Height mm	Length mm	SINGLE			DOUBLE		
		Stelrad UIN	Heat output Watts	Heat output Btu/hr	Stelrad UIN	Heat output Watts	Heat output Btu/hr
592	500	448363h	501	1,709	448414h	849	2,897
	600	448364h	601	2,051	448415h	1,018	3,474
	700	448365h	701	2,392	448416h	1,188	4,054
	800	448366h	802	2,737	448417h	1,358	4,634
	900	448367h	902	3,078	448418h	1,527	5,210
	1000	448368h	1,002	3,419	448419h	1,697	5,790
	1100	448369h	1,102	3,760	448420h	1,867	6,370
	1200	448370h	1,202	4,101	448421h	2,036	6,947
	1400	448371h	1,403	4,787	448422h	2,376	8,107
	1600	148372h	1,603	5,470	148423h	2,715	9,264
	1800	148373h	1,804	6,156	148424h	3,055	10,424
	2000	148374h	2,004	6,838	148425h	3,394	11,581
	2200	148375h	2,204	7,520	148426h	3,733	12,738
	2400	148376h	2,405	8,206	148427h	4,073	13,898
	2600	148377h	2,605	8,889	148428h	4,412	15,054
	2800	148378h	2,806	9,574	148429h	4,752	16,214
3000	148379h	3,006	10,257	148430h	5,091	17,371	
740	500	148380h	598	2,040	148431h	1,001	3,416
	600	148381h	718	2,450	148432h	1,201	4,098
	700	148382h	837	2,856	148433h	1,401	4,780
	800	148383h	957	3,265	148434h	1,602	5,466
	900	148384h	1,076	3,671	148435h	1,802	6,149
	1000	148385h	1,196	4,081	148436h	2,002	6,831
	1100	148386h	1,316	4,490	148437h	2,202	7,514
	1200	148387h	1,435	4,896	148438h	2,402	8,196
	1400	148388h	1,674	5,712	148439h	2,803	9,564
	1600	148389h	1,914	6,531	148440h	3,203	10,929
	1800	148390h	2,153	7,346	148441h	3,604	12,297
	2000	148391h	2,392	8,162	148442h	4,004	13,662
	2200	148392h	2,631	8,977	148443h	4,404	15,027
	2400	148393h	2,870	9,793	148444h	4,805	16,395
	2600	148394h	3,110	10,612	148445h	5,205	17,760
	2800	148395h	3,349	11,427	148446h	5,606	19,128
3000	148396h	3,588	12,243	148447h	6,006	20,493	

CONCORD PLANE COLOURED



50Δt
(75/65/20°C)

Height mm	Length mm	SINGLE			DOUBLE		
		Stelrad UIN	Heat output Watts	Heat output Btu/h	Stelrad UIN	Heat output Watts	Heat output Btu/h
444	500	148478h	392	1,338	148529h	685	2,337
	600	148479h	470	1,604	148530h	821	2,801
	700	148480h	549	1,873	148531h	958	3,269
	800	148481h	627	2,139	148532h	1,095	3,736
	900	148482h	706	2,409	148533h	1,232	4,204
	1000	148483h	784	2,675	148534h	1,369	4,671
	1100	148484h	862	2,941	148535h	1,506	5,139
	1200	148485h	941	3,211	148536h	1,643	5,606
	1400	148486h	1,098	3,747	148537h	1,917	6,541
	1600	148487h	1,254	4,279	148538h	2,190	7,473
	1800	148488h	1,411	4,815	148539h	2,464	8,408
	2000	148489h	1,568	5,350	148540h	2,738	9,342
	2200	148490h	1,725	5,886	148541h	3,012	10,277
	2400	148491h	1,882	6,422	148542h	3,286	11,212
	2600	148492h	2,038	6,954	148543h	3,559	12,144
	2800	148493h	2,195	7,490	148544h	3,833	13,079
3000	148494h	2,352	8,025	148545h	4,107	14,014	
592	500	148495h	501	1,709	148546h	849	2,897
	600	148496h	601	2,051	148547h	1,018	3,474
	700	148497h	701	2,392	148548h	1,188	4,054
	800	148498h	802	2,737	148549h	1,358	4,634
	900	148499h	902	3,078	148550h	1,527	5,210
	1000	148500h	1,002	3,419	148551h	1,697	5,790
	1100	148501h	1,102	3,760	148552h	1,867	6,370
	1200	148502h	1,202	4,101	148553h	2,036	6,947
	1400	148503h	1,403	4,787	148554h	2,376	8,107
	1600	148504h	1,603	5,470	148555h	2,715	9,264
	1800	148505h	1,804	6,156	148556h	3,055	10,424
	2000	148506h	2,004	6,838	148557h	3,394	11,581
	2200	148507h	2,204	7,520	148558h	3,733	12,738
	2400	148508h	2,405	8,206	148559h	4,073	13,898
	2600	148509h	2,605	8,889	148560h	4,412	15,054
	2800	148510h	2,806	9,574	148561h	4,752	16,214
3000	148511h	3,006	10,257	148562h	5,091	17,371	
740	500	148512h	598	2,040	148563h	1,001	3,416
	600	148513h	718	2,450	148564h	1,201	4,098
	700	148514h	837	2,856	148565h	1,401	4,780
	800	148515h	957	3,265	148566h	1,602	5,466
	900	148516h	1,076	3,671	148567h	1,802	6,149
	1000	148517h	1,196	4,081	148568h	2,002	6,831
	1100	148518h	1,316	4,490	148569h	2,202	7,514
	1200	148519h	1,435	4,896	148570h	2,402	8,196
	1400	148520h	1,674	5,712	148571h	2,803	9,564
	1600	148521h	1,914	6,531	148572h	3,203	10,929
	1800	148522h	2,153	7,346	148573h	3,604	12,297
	2000	148523h	2,392	8,162	148574h	4,004	13,662
	2200	148524h	2,631	8,977	148575h	4,404	15,027
	2400	148525h	2,870	9,793	148576h	4,805	16,395
	2600	148526h	3,110	10,612	148577h	5,205	17,760
	2800	148527h	3,349	11,427	148578h	5,606	19,128
3000	148528h	3,588	12,243	148579h	6,006	20,493	

SIZES AND HEATING SPECIFICATIONS

CONCORD VERTICAL 50Δt (75/65/20°C)



Height mm	Length mm	SINGLE		DOUBLE			
		Stelrad UIN	Heat output Watts	Btu/h	Stelrad UIN	Heat output Watts	Btu/h
1800	444	448340h	852	2,907	448640h	1,254	4,279
	592	448341h	1,136	3,876	448641h	1,672	5,705
	740	448342h	1,420	4,845	448642h	2,090	7,131
2000	444	448343h	942	3,214	448643h	1,386	4,729
	592	448344h	1,256	4,286	448644h	1,848	6,306
	740	448345h	1,570	5,357	448645h	2,310	7,882

CONCORD VERTICAL COLOURED 50Δt (75/65/20°C)



Height mm	Length mm	SINGLE			DOUBLE		
		Stelrad UIN	Heat output Watts	Btu/h	Stelrad UIN	Heat output Watts	Btu/h
1800	444	148472h	852	2,907	148646h	1,254	4,279
	592	148473h	1,136	3,876	148647h	1,672	5,705
	740	148474h	1,420	4,845	148648h	2,090	7,131
2000	444	148475h	942	3,214	148649h	1,386	4,729
	592	148476h	1,256	4,286	148650h	1,848	6,306
	740	148477h	1,570	5,357	148651h	2,310	7,882

CONCORD VERTICAL CONCEPT 50Δt (75/65/20°C)



Height mm	Length mm	SINGLE		DOUBLE			
		Stelrad UIN	Heat output Watts	Btu/h	Stelrad UIN	Heat output Watts	Btu/h
1800	444	448652h	852	2,907	448655h	1,254	4,279
	592	448653h	1,136	3,876	448656h	1,672	5,705
	740	448654h	1,420	4,845	448657h	2,090	7,131

CONCORD CHROME VERTICAL 50Δt (75/65/20°C)



Height mm	Length mm	SINGLE		
		Stelrad UIN	Heat output Watts	Btu/h
1800	310	751101h	395	1,348
	390	751102h	495	1,688
	470	751103h	528	1,801
	604	751104h	654	2,232

SIZES AND HEATING SPECIFICATIONS

CONCORD SLIMLINE **50Δt** (75/65/20°C)



SINGLE

Height mm	Length mm	Stelrad UIN	Heat output	
			Watts	Btu/h
1800	320	448300h	872	2,975
	440	448301h	1,199	4,091
	520	448302h	1,417	4,835
	640	448303h	1,744	5,951
2000	320	448304h	978	3,337
	440	448305h	1,344	4,586
	520	448306h	1,589	5,422
	640	448307h	1,956	6,674

CONCORD SLIMLINE COLOURED **50Δt** (75/65/20°C)



SINGLE

Height mm	Length mm	Stelrad UIN	Heat output	
			Watts	Btu/h
1800	320	148448h	872	2,975
	440	148449h	1,199	4,091
	520	148450h	1,417	4,835
	640	148451h	1,744	5,951
2000	320	148452h	978	3,337
	440	148453h	1,344	4,586
	520	148454h	1,589	5,422
	640	148455h	1,956	6,674

CONCORD SLIMLINE CONCEPT **50Δt** (75/65/20°C)



SINGLE

Height mm	Length mm	Stelrad UIN	Heat output	
			Watts	Btu/h
1800	320	448658h	872	2,975
	440	448659h	1,199	4,091
	520	448660h	1,417	4,835
	640	448661h	1,744	5,951

COLUMN HORIZONTAL



50Δt (75/65/20°C)

2 COLUMN

3 COLUMN

4 COLUMN

Height mm	Length mm	Stelrad UIN	Heat output		Stelrad UIN	Heat output		Stelrad UIN	Heat output	
			Watts	Btu/hr		Watts	Btu/hr		Watts	Btu/hr
300	444	-	-	-	463000h	288	983	463007h	377	1,287
	628	-	-	-	463001h	416	1,420	463008h	545	1,860
	858	-	-	-	463002h	576	1,966	463009h	754	2,573
	1042	-	-	-	463003h	704	2,403	463010h	922	3,147
	1272	-	-	-	463004h	864	2,949	463011h	1,131	3,860
	1456	-	-	-	463005h	992	3,386	-	-	-
	1870	-	-	-	463006h	1,280	4,369	-	-	-
500	444	-	-	-	463016h	464	1,584	463023h	608	2,075
	628	463012h	499	1,703	463017h	671	2,290	463024h	879	3,000
	858	463013h	691	2,358	463018h	929	3,171	463025h	1,217	4,154
	1042	463014h	845	2,884	463019h	1,135	3,874	463026h	1,487	5,075
	1272	463015h	1,037	3,539	463020h	1,393	4,754	463027h	1,825	6,229
	1456	-	-	-	463021h	1,600	5,461	-	-	-
	1870	-	-	-	463022h	2,064	7,044	-	-	-
600	444	-	-	-	463032h	548	1,870	463039h	718	2,451
	628	463028h	589	2,010	463033h	792	2,703	463040h	1,037	3,539
	858	463029h	815	2,782	463034h	1,096	3,741	463041h	1,436	4,901
	1042	463030h	997	3,403	463035h	1,340	4,573	463042h	1,756	5,993
	1272	463031h	1,223	4,174	463036h	1,644	5,611	463043h	2,155	7,355
	1456	-	-	-	463037h	1,888	6,444	-	-	-
	1870	-	-	-	463038h	2,436	8,314	-	-	-
750	444	-	-	-	-	-	-	463049h	877	2,993
	628	-	-	-	-	-	-	463050h	1,266	4,321
	858	-	-	-	463044h	1,337	4,563	463051h	1,753	5,983
	1042	-	-	-	463045h	1,635	5,580	463052h	2,143	7,314
	1272	-	-	-	463046h	2,006	6,846	463053h	2,630	8,976
	1456	-	-	-	463047h	2,303	7,860	-	-	-
	1870	-	-	-	463048h	2,972	10,143	-	-	-

SIZES AND HEATING SPECIFICATIONS

COLUMN CONCEPT

50Δt

(75/65/20°C)



Height mm	Length mm	3 COLUMN			4 COLUMN		
		Stelrad UIN	Heat output Watts	Heat output Btu/h	Stelrad UIN	Heat output Watts	Heat output Btu/h
600	628	463133h	792	2,703	463140h	1,037	3,539
	858	463134h	1,096	3,741	463141h	1,436	4,901
	1042	463135h	1,340	4,573	463142h	1,756	5,993
	1272	463136h	1,644	5,611	463143h	2,155	7,355

COLUMN VERTICAL

50Δt

(75/65/20°C)



Height mm	Length mm	2 COLUMN		
		Stelrad UIN	Watts	Heat output Btu/hr
1800	352	463054h	868	2,962
	444	463055h	1,116	3,809
2000	352	463056h	966	3,297
	444	463057h	1,242	4,239
2500	352	463058h	1,197	4,085
	444	463059h	1,539	5,253

COLUMN HORIZONTAL COLOURED

50Δt

(75/65/20°C)



Height mm	Length mm	2 COLUMN			3 COLUMN			4 COLUMN		
		Stelrad UIN	Watts	Heat output Btu/hr	Stelrad UIN	Watts	Heat output Btu/hr	Stelrad UIN	Watts	Heat output Btu/hr
300	444	-	-	-	163000h	288	983	163007h	377	1,287
	628	-	-	-	163001h	416	1,420	163008h	545	1,860
	858	-	-	-	163002h	576	1,966	163009h	754	2,573
	1042	-	-	-	163003h	704	2,403	163010h	922	3,147
	1272	-	-	-	163004h	864	2,949	163011h	1,131	3,860
	1456	-	-	-	163005h	992	3,386	-	-	-
	1870	-	-	-	163006h	1,280	4,369	-	-	-
500	444	163012h	499	1,703	163016h	464	1,584	163023h	608	2,075
	628	163013h	691	2,358	163017h	671	2,290	163024h	879	3,000
	858	163014h	845	2,884	163018h	929	3,171	163025h	1,217	4,154
	1042	163015h	1,037	3,539	163019h	1,135	3,874	163026h	1,487	5,075
	1272	-	-	-	163020h	1,393	4,754	163027h	1,825	6,229
	1456	-	-	-	163021h	1,600	5,461	-	-	-
	1870	-	-	-	163022h	2,064	7,044	-	-	-
600	444	-	-	-	163032h	548	1,870	163039h	718	2,451
	628	163028h	589	2,010	163033h	792	2,703	163040h	1,037	3,539
	858	163029h	815	2,782	163034h	1,096	3,741	163041h	1,436	4,901
	1042	163030h	997	3,403	163035h	1,340	4,573	163042h	1,756	5,993
	1272	163031h	1,223	4,174	163036h	1,644	5,611	163043h	2,155	7,355
	1456	-	-	-	163037h	1,888	6,444	-	-	-
	1870	-	-	-	163038h	2,436	8,314	-	-	-
750	444	-	-	-	-	-	-	163049h	877	2,993
	628	-	-	-	-	-	-	163050h	1,266	4,321
	858	-	-	-	163044h	1,337	4,563	163051h	1,753	5,983
	1042	-	-	-	163045h	1,635	5,580	163052h	2,143	7,314
	1272	-	-	-	163046h	2,006	6,846	163053h	2,630	8,976
	1456	-	-	-	163047h	2,303	7,860	-	-	-
	1870	-	-	-	163048h	2,972	10,143	-	-	-

COLUMN VERTICAL CONCEPT

50Δt

(75/65/20°C)



Height mm	Length mm	2 COLUMN		
		Stelrad UIN	Watts	Heat output Btu/hr
1800	444	463155h	1,116	3,809
2000	444	463157h	1,242	4,239

SIZES AND HEATING SPECIFICATIONS

COLUMN VERTICAL COLOURED



50Δt
(75/65/20°C)

2 COLUMN

Height mm	Length mm	Stelrad UIN	Watts	Heat output Btu/hr
1800	352	163054h	868	2,962
	444	163055h	1,116	3,809
2000	352	163056h	966	3,297
	444	163057h	1,242	4,239
2500	352	163058h	1,197	4,085
	444	163059h	1,539	5,253

CAST IRON COLUMN



50Δt
(75/65/20°C)

4 COLUMN

Height mm	Length mm	Stelrad UIN	Watts	Heat output Btu/hr	Weight (kg)
360	512	264073h	344	1,174	28
	573	264074h	387	1,320	31
	634	264075h	430	1,467	34
	695	264076h	473	1,614	38
	756	264077h	516	1,761	41
	816	264078h	559	1,907	45
	877	264079h	602	2,054	48
	938	264080h	645	2,201	52
	999	264081h	688	2,347	55
	1060	264082h	731	2,494	59
	1120	264083h	774	2,641	62
	1181	264084h	817	2,788	65

For important information regarding weight and delivery please visit www.stelrad.com

CAST IRON COLUMN (CONTINUED)



50Δt
(75/65/20°C)

4 COLUMN

Height mm	Length mm	Stelrad UIN	Watts	Heat output Btu/hr	Weight (kg)
505	512	264085h	520	1,774	34
	573	264086h	585	1,996	38
	634	264087h	650	2,218	42
	695	264088h	715	2,440	46
	756	264089h	780	2,661	50
	816	264090h	845	2,883	55
	877	264091h	910	3,105	59
	938	264092h	975	3,327	63
	999	264093h	1,040	3,548	67
	1060	264094h	1,105	3,770	71
	1120	264095h	1,170	3,992	75
	1181	264096h	1,235	4,214	80
	660	512	264001h	744	2,539
573		264002h	837	2,856	50
634		264003h	930	3,173	56
695		264004h	1,023	3,490	61
756		264005h	1,116	3,808	67
816		264006h	1,209	4,125	72
877		264007h	1,302	4,442	78
938		264008h	1,395	4,760	83
999		264009h	1,488	5,077	89
1060		264010h	1,581	5,394	94
1120		264011h	1,674	5,712	100
1181		264012h	1,767	6,029	106
760		512	264013h	864	2,948
	573	264014h	972	3,316	56
	634	264015h	1,080	3,685	62
	695	264016h	1,188	4,053	68
	756	264017h	1,296	4,422	75
	816	264018h	1,404	4,790	81
	877	264019h	1,512	5,159	87
	938	264020h	1,620	5,527	93
	999	264021h	1,728	5,896	100
	1060	264022h	1,836	6,264	106
	1120	264023h	1,944	6,633	112
	1181	264024h	2,052	7,001	118
	960	512	264025h	1,112	3,794
573		264026h	1,251	4,268	71
634		264027h	1,390	4,743	79
695		264028h	1,529	5,217	86
756		264029h	1,668	5,691	94
816		264030h	1,807	6,165	102
877		264031h	1,946	6,640	110
938		264032h	2,085	7,114	118
999		264033h	2,224	7,588	126
1060		264034h	2,363	8,063	133
1120		264035h	2,502	8,537	141
1181		264036h	2,641	9,011	149

SIZES AND HEATING SPECIFICATIONS

CAST IRON COLUMN (CONTINUED)



50Δt
(75/65/20°C)

6 COLUMN

Height mm	Length mm	Stelrad UIN	Heat output		Weight (kg)
			Watts	Btu/hr	
505	512	264037h	760	2,593	67
	573	264038h	855	2,917	75
	634	264039h	950	3,241	84
	695	264040h	1,045	3,566	92
	756	264041h	1,140	3,890	100
	816	264042h	1,235	4,214	109
	877	264043h	1,330	4,538	117
	938	264044h	1,425	4,862	125
	999	264045h	1,520	5,186	134
	1060	264046h	1,615	5,510	142
	1120	264047h	1,710	5,835	150
1181	264048h	1,805	6,159	159	
660	512	264049h	1,064	3,630	77
	573	264050h	1,197	4,084	86
	634	264051h	1,330	4,538	96
	695	264052h	1,463	4,992	105
	756	264053h	1,596	5,446	115
	816	264054h	1,729	5,899	125
	877	264055h	1,862	6,353	134
	938	264056h	1,995	6,807	144
	999	264057h	2,128	7,261	153
	1060	264058h	2,261	7,715	163
	1120	264059h	2,394	8,168	173
1181	264060h	2,527	8,622	182	
960	512	264061h	1,576	5,377	98
	573	264062h	1,773	6,049	111
	634	264063h	1,970	6,722	123
	695	264064h	2,167	7,394	135
	756	264065h	2,364	8,066	147
	816	264066h	2,561	8,738	160
	877	264067h	2,758	9,410	172
	938	264068h	2,955	10,082	184
	999	264069h	3,152	10,755	196
	1060	264070h	3,349	11,427	209
	1120	264071h	3,546	12,099	221
1181	264072h	3,743	12,771	233	

DELIVERY INFORMATION (FOR CAST IRON COLUMN ONLY)

Please note: Due to the weight of the product a 2-man lift is required and there is a £84 incl. VAT shipping charge per order, per destination for orders under £1200 incl. VAT.

The delivery driver is only able to stop at the closest point on the road at the nearest accessible external hard standing, i.e. pavement.

Due to health and safety legislation the driver is prohibited from lifting any heavy goods (25kg = max. single person lift). They are not insured to enter the property. It is your responsibility to organise the manpower thereafter to be available to move your radiators to a suitable and dry storage area.

Cast Iron Column radiators are delivered individually wrapped with each individual radiator layer separated with a thick card then secured flat onto the pallet(s).

Cast Iron Column radiators have up to a 14 day lead time.

Returning Costs: To return a Cast Iron Column radiator(s) there is a restock charge of £42 per radiator (inclusive of VAT) and a carrier charge of £84 (inclusive of VAT). If there are more than five radiators being returned the carrier charge may increase, this will be discussed when you make your return request to Stelrad.

LST STANDARD HORIZONTAL LINE



50Δt
(75/65/20°C)

K1

P+

K2

Height mm	Length mm	Stelrad UIN	Heat output		Stelrad UIN	Heat output		Stelrad UIN	Heat output	
			Watts	Btu/hr		Watts	Btu/hr		Watts	Btu/hr
500	560	245000h	196	669	245008h	284	969	245016h	348	1,187
	760	245001h	293	1,000	245009h	426	1,454	245017h	522	1,781
	960	245002h	391	1,334	245010h	568	1,938	245018h	696	2,375
	1160	245003h	489	1,668	245011h	710	2,423	245019h	870	2,968
	1360	245004h	587	2,003	245012h	852	2,907	245020h	1,044	3,562
	1560	245005h	685	2,337	245013h	994	3,392	245021h	1,218	4,156
	1760	245006h	782	2,668	245014h	1,136	3,876	245022h	1,392	4,750
	1960	245007h	880	3,003	245015h	1,278	4,361	245023h	1,566	5,343
	560	245024h	290	989	245032h	386	1,317	245040h	478	1,631
	760	245025h	435	1,484	245033h	580	1,979	245041h	717	2,446
650	960	245026h	580	1,979	245034h	773	2,637	245042h	956	3,262
	1160	245027h	725	2,474	245035h	966	3,296	245043h	1,195	4,077
	1360	245028h	870	2,968	245036h	1,159	3,955	245044h	1,434	4,893
	1560	245029h	1,015	3,463	245037h	1,352	4,613	245045h	1,673	5,708
	1760	245030h	1,160	3,958	245038h	1,546	5,275	245046h	1,912	6,524
	1960	245031h	1,305	4,453	245039h	1,739	5,933	245047h	2,151	7,339
	460	245072h	274	935	-	-	-	245073h	461	1,573
	560	245048h	365	1,245	245056h	501	1,709	245064h	615	2,098
800	760	245049h	548	1,870	245057h	751	2,562	245065h	922	3,146
	960	245050h	730	2,491	245058h	1,002	3,419	245066h	1,230	4,197
	1160	245051h	913	3,115	245059h	1,252	4,272	245067h	1,537	5,244
	1360	245052h	1,096	3,740	245060h	1,502	5,125	245068h	1,844	6,292
	1560	245053h	1,278	4,361	245061h	1,753	5,981	245069h	2,152	7,343
	1760	245054h	1,461	4,985	245062h	2,003	6,834	245070h	2,459	8,390
	1960	245055h	1,643	5,606	245063h	2,254	7,691	245071h	2,767	9,441

SIZES AND HEATING SPECIFICATIONS

LST i PLUS HORIZONTAL LINE



50Δt
(75/65/20°C)

Height mm	Length mm	K1		P+		K2	
		Stelrad UIN	Heat output Watts Btu/hr	Stelrad UIN	Heat output Watts Btu/hr	Stelrad UIN	Heat output Watts Btu/hr
500	650	245200h	196 669	245248h	284 969	245224h	348 1,187
	850	245201h	293 1,000	245249h	426 1,454	245225h	522 1,781
	1050	245202h	391 1,334	245250h	568 1,938	245226h	696 2,375
	1250	245203h	489 1,668	245251h	710 2,423	245227h	870 2,968
	1450	245204h	587 2,003	245252h	852 2,907	245228h	1,044 3,562
	1650	245205h	685 2,337	245253h	994 3,392	245229h	1,218 4,156
	1850	245206h	782 2,668	245254h	1,136 3,876	245230h	1,392 4,750
	2050	245207h	880 3,003	245255h	1,278 4,361	245231h	1,566 5,343
	650	650	245208h	290 989	245256h	386 1,317	245232h
850		245209h	435 1,484	245257h	580 1,979	245233h	717 2,446
1050		245210h	580 1,979	245258h	773 2,637	245234h	956 3,262
1250		245211h	725 2,474	245259h	966 3,296	245235h	1,195 4,077
1450		245212h	870 2,968	245260h	1,159 3,955	245236h	1,434 4,893
1650		245213h	1,015 3,463	245261h	1,352 4,613	245237h	1,673 5,708
1850		245214h	1,160 3,958	245262h	1,546 5,275	245238h	1,912 6,524
2050		245215h	1,305 4,453	245263h	1,739 5,933	245239h	2,151 7,339
800		650	245216h	365 1,245	245264h	501 1,709	245240h
	850	245217h	548 1,870	245265h	751 2,562	245241h	922 3,146
	1050	245218h	730 2,491	245266h	1,002 3,419	245242h	1,230 4,197
	1250	245219h	913 3,115	245267h	1,252 4,272	245243h	1,537 5,244
	1450	245220h	1,096 3,740	245268h	1,502 5,125	245244h	1,844 6,292
	1650	245221h	1,278 4,361	245269h	1,753 5,981	245245h	2,152 7,343
	1850	245222h	1,461 4,985	245270h	2,003 6,834	245246h	2,459 8,390
	2050	245223h	1,643 5,606	245271h	2,254 7,691	245247h	2,767 9,441

HEAVY DUTY DECO



50Δt
(75/65/20°C)

Height mm	Length mm	K1		K2	
		Stelrad UIN	Heat output Watts Btu/h	Stelrad UIN	Heat output Watts Btu/h
450	400	7641104h	268 914	7642204h	500 1,706
	600	7641106h	403 1,375	7642206h	750 2,559
	800	7641108h	537 1,832	7642208h	999 3,409
	1000	7641110h	672 2,293	7642210h	1,249 4,262
	1200	7641112h	806 2,750	7642212h	1,499 5,115
	1400	7641114h	941 3,211	7642214h	1,749 5,968
	1600	7641116h	1,075 3,668	7642216h	1,999 6,821
	1800	7641118h	1,209 4,125	7642218h	2,248 7,670
	2000	7641120h	1,362 4,647	7642220h	2,546 8,687
600	400	7661104h	348 1,187	7662204h	640 2,184
	600	7661106h	522 1,781	7662206h	961 3,280
	800	7661108h	696 2,375	7662208h	1,281 4,372
	1000	7661110h	870 2,968	7662210h	1,601 5,464
	1200	7661112h	1,044 3,562	7662212h	1,921 6,556
	1400	7661114h	1,218 4,156	7662214h	2,241 7,649
	1600	7661116h	1,392 4,750	7662216h	2,562 8,744
	1800	7661118h	1,566 5,343	7662218h	2,882 9,836
	2000	7661120h	1,740 5,937	7662220h	3,202 10,928

HEAVY DUTY PLANAR



50Δt
(75/65/20°C)

Height mm	Length mm	K1		K2	
		Stelrad UIN	Heat output Watts Btu/h	Stelrad UIN	Heat output Watts Btu/h
450	400	141259h	268 915	141269h	500 1,705
	600	141261h	403 1,376	141271h	750 2,559
	800	141262h	537 1,834	141272h	999 3,410
	1000	141263h	672 2,292	141273h	1,249 4,262
	1200	141264h	806 2,751	141274h	1,499 5,114
	1400	141265h	941 3,209	141275h	1,749 5,967
	1600	141266h	1,075 3,668	141276h	1,999 6,819
	1800	141267h	1,209 4,126	141277h	2,248 7,672
	2000	141268h	1,362 4,648	141278h	2,546 8,686
600	400	141279h	348 1,187	141289h	640 2,184
	600	141281h	522 1,781	141291h	961 3,280
	800	141282h	696 2,375	141292h	1,281 4,372
	1000	141283h	870 2,968	141293h	1,601 5,464
	1200	141284h	1,044 3,562	141294h	1,921 6,556
	1400	141285h	1,218 4,156	141295h	2,241 7,649
	1600	141286h	1,392 4,750	141296h	2,563 8,744
	1800	141287h	1,566 5,343	141297h	2,883 9,836
	2000	141288h	1,740 5,937	141298h	3,203 10,928

SIZES AND HEATING SPECIFICATIONS

MINI BATHROOM TOWEL RADIATOR

50Δt
(75/65/20°C)



Height mm	Length mm	STRAIGHT WHITE			STRAIGHT CHROME		
		Stelrad UIN	Watts	Heat output Btu/hr	Stelrad UIN	Watts	Heat output Btu/hr
678	400	147000h	273	931	147001h	175	597

MATTE BLACK TOWEL RAIL

50Δt
(75/65/20°C)



Height mm	Length mm	Stelrad UIN	Watts	Heat output Btu/hr
700	420	751105h	282	962
862	500	751106h	374	1,276
1211	500	751107h	576	1,965

BATHROOM TOWEL RADIATOR

50Δt
(75/65/20°C)



Height mm	Length mm	STRAIGHT WHITE			STRAIGHT CHROME		
		Stelrad UIN	Watts	Heat output Btu/hr	Stelrad UIN	Watts	Heat output Btu/hr
760	500	148070h	376	1,282	147002h	246	839
	600	148071h	445	1,517	147003h	294	1,003
1211	500	148072h	576	1,964	147004h	379	1,292
	600	148073h	686	2,339	147005h	453	1,545
1744	500	148074h	844	2,878	142768h	557	1,899
	600	148075h	1,000	3,410	142769h	667	2,274

Height mm	Length mm	CURVED WHITE			CURVED CHROME		
		Stelrad UIN	Watts	Heat output Btu/hr	Stelrad UIN	Watts	Heat output Btu/hr
760	500	147006h	376	1,282	147012h	246	839
	600	147007h	445	1,517	147013h	294	1,003
1211	500	147008h	576	1,964	147014h	379	1,292
	600	147009h	686	2,339	147015h	453	1,545
1744	500	147010h	844	2,878	147016h	557	1,899
	600	147011h	1,000	3,10	147017h	667	2,274

STAINLESS STEEL TOWEL RAIL

50Δt
(75/65/20°C)



Height mm	Length mm	POLISHED STEEL			BRUSHED STEEL		
		Stelrad UIN	Watts	Heat output Btu/hr	Stelrad UIN	Watts	Heat output Btu/hr
750	500	741001h	190	648	742001h	190	648
	600	741002h	299	1,020	742002h	299	1,020
1200	500	741003h	340	1,160	742003h	350	1,160
	600	741004h	370	1,262	742004h	370	1,262

SIZES AND HEATING SPECIFICATIONS

COMO



50Δt

(75/65/20°C)

STRAIGHT

Height mm	Length mm	Stelrad UIN	Watts	Heat output Btu/hr
750	500	720001h	247	843
1000	500	720002h	306	1,044
1200	500	720003h	341	1,164
1500	500	720004h	421	1,437

CALIENTE RAIL



50Δt

(75/65/20°C)

STRAIGHT SINGLE

STRAIGHT DOUBLE

Height mm	Length mm	STRAIGHT SINGLE		STRAIGHT DOUBLE			
		Stelrad UIN	Watts	Btu/hr	Stelrad UIN	Watts	Btu/hr
755	450	407501450h	389	1,327	407502450h	565	1,928
	500	407501500h	431	1,471	407502500h	626	2,136
	600	407501600h	517	1,764	407502600h	749	2,556
	750	407501750h	645	2,201	407502750h	934	3,187
1199	450	401101450h	615	2,098	401102450h	868	2,962
	500	401101500h	675	2,303	401102500h	963	3,286
	600	401101600h	794	2,709	401102600h	1,154	3,937
	750	401101750h	972	3,316	401102750h	1,441	4,917
1791	450	401701450h	900	3,071	401702450h	1,268	4,326
	500	401701500h	986	3,364	401702500h	1,402	4,784
	600	401701600h	1,158	3,951	401702600h	1,670	5,698
	750	401701750h	1,416	4,831	401702750h	2,073	7,073
2013	450	402001450h	1,002	3,419	402002450h	1,427	4,869
	500	402001500h	1,099	3,750	402002500h	1,576	5,377
	600	402001600h	1,294	4,415	402002600h	1,874	6,394
	750	402001750h	1,586	5,411	402002750h	2,321	7,919

UINs are for the white products and colour codes can be provided upon request.



We recommend a Centre Tap TRV to complete the look. See page 157 for more information.

CONCORD RAIL



50Δt

(75/65/20°C)

STRAIGHT

Height mm	Length mm	Stelrad UIN	Watts	Heat output Btu/hr
731	450	148581h	342	1,167
	600	148582h	447	1,525
1186	450	148583h	530	1,808
	600	148584h	694	2,368
1511	450	148585h	666	2,272
	600	148586h	869	2,965
1771	450	148587h	777	2,651
	600	148588h	1,010	3,446

UINs are for the white products and colour codes can be provided upon request.



We recommend a Centre Tap TRV to complete the look. See page 157 for more information.

CONCORD SIDE CHROME



50Δt

(75/65/20°C)

STRAIGHT

Height mm	Length mm	Stelrad UIN	Watts	Heat output Btu/hr
830	500	712001h	221	754
1130	500	712002h	297	1,013
1430	500	712003h	371	1,266
1730	500	712004h	448	1,529



We recommend a Centre Tap TRV to complete the look. See page 157 for more information.

SIZES AND HEATING SPECIFICATIONS

CONCORD SIDE CONCEPT



50Δt
(75/65/20°C)

STRAIGHT

Height mm	Length mm	Stelrad UIN	Watts	Heat output Btu/hr
830	500	711001h	374	1,276
1130	500	711002h	483	1,648
1430	500	711003h	602	2,054



We recommend a Centre Tap TRV to complete the look. See page 157 for more information.

EXCLUSIVE TO STELRAD GROUP PLC LECCO



50Δt
(75/65/20°C)

STRAIGHT

Height mm	Length mm	Stelrad UIN	Watts	Heat output Btu/hr
1200	500	730001h	200	682

ULTRA



50Δt
(75/65/20°C)

P+

Front Panel Height mm	Emitter Height mm	Front Panel Length mm	Emitter Length mm	Stelrad UIN	Watts	Heat output Btu/hr
645	600	470	400	83612104h	474	1,616
		670	600	83612106h	710	2,24
		870	800	83612108h	947	3,232
		1070	1000	83612110h	1,184	4,040
		1270	1200	83612112h	1,421	4,848
		1470	1400	83612114h	1,658	5,656
		1670	1600	83612116h	1,894	6,464
		1870	1800	83612118h	2,131	7,272
		2070	2000	83612120h	2,368	8,080

K2

Front Panel Height mm	Emitter Height mm	Front Panel Length mm	Emitter Length mm	Stelrad UIN	Watts	Heat output Btu/hr
545	500	470	400	83512204h	522	1,781
		670	600	83512206h	782	2,668
		870	800	83512208h	1,043	3,559
		1070	1000	83512210h	1,304	4,449
		1270	1200	83512212h	1,565	5,340
		1470	1400	83512214h	1,826	6,231
		1670	1600	83512216h	2,086	7,118
		1870	1800	83512218h	2,347	8,008
		2070	2000	83512220h	2,608	8,899
645	600	470	400	83612204h	599	2,044
		670	600	83612206h	899	3,068
		870	800	83612208h	1,198	4,088
		1070	1000	83612210h	1,498	5,111
		1270	1200	83612212h	1,798	6,135
		1470	1400	83612214h	2,097	7,155
		1670	1600	83612216h	2,397	8,179
		1870	1800	83612218h	2,696	9,199
		2070	2000	83612220h	2,996	10,223

ULTRA TOWEL RAIL BAR

Fits emitter length	Stelrad UIN
400mm wide	83100004
600mm wide	83100006
800mm wide	83100008
1000mm wide	83100010

Towel rail bar is 120mm wider than actual radiator. Maximum of one towel rail bar per radiator. For more information see accessories page 156.

SIZES AND HEATING SPECIFICATIONS

VERTICAL ULTRA

50Δt

(75/65/20°C)



K2

Front Panel Height mm	Emitter Height mm	Front Panel Length mm	Emitter Length mm	Stelrad UIN	Heat output Watts	Heat output Btu/hr
1040	1000	470	400	86110224h	857	2,924
		570	500	86110225h	1,071	3,654
		670	600	86110226h	1,285	4,384
1240	1200	470	400	86112224h	999	3,409
		570	500	86112225h	1,249	4,262
		670	600	86112226h	1,499	5,115
1840	1800	470	400	86118224h	1,476	5,036
		570	500	86118225h	1,845	6,295
		670	600	86118226h	2,214	7,554
2040	2000	470	400	86120224h	1,584	5,405
		570	500	86120225h	1,980	6,756
		670	600	86120226h	2,376	8,107

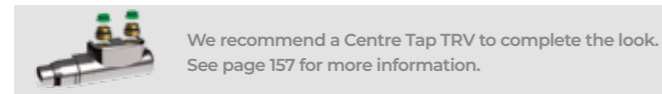

VERTICAL ULTRA TOWEL RAIL BAR

Fits emitter length	Stelrad UIN	Radiator Height	Max no. of bars
400mm wide	83200004	1000	1
500mm wide	83200005	1200	2
600mm wide	83200006	1800	3
		2000	3

Towel rail bar is 120mm wider than actual radiator. Maximum of three towel rail bars per radiator. For more information see accessories page 156.



Stelrad, the UK's No.1 radiator manufacturer is offering the first Green Compact radiator range using XCarb® steel. This steel is made in an electric arc furnace using high levels of scrap steel and 100% renewable electricity and is supported by an independently verified Environmental Product Declaration.

This range contributes directly to a reduction in atmospheric CO₂ today and accelerates decarbonisation in the future – another first from Stelrad.

XCarb®
ArcelorMittal Recycled
and renewably produced

Find out more



ACCESSORIES

COLUMN HORIZONTAL FLOOR MOUNTING BRACKETS (SOLD IN PAIRS)



Column Horizontal in Traffic White RAL 9016 UIN 148137
 Column Concept in Anthracite grey A7016 UIN 148138

TOWEL RAIL ELECTRIC HEATER ELEMENT

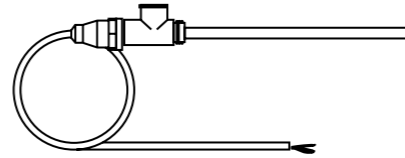

Electric heating element
 150 watt UIN 141536
 300 watt UIN 141531
 615 watt UIN 141532

Available for the Bathroom Towel Radiator, Stainless Steel Towel Rail, Caliente Rail, Concord Rail, Como & Lecco.

FLOOR MOUNTING BRACKETS (SOLD AS SINGLES)



300mm UIN 9179
 450mm UIN 9180
 600mm UIN 9181

Available for Classic Compact, Compact Vertical Line, Compact Horizontal Line and Compact Flat.
 Recommended to use 3 on products that are 1800mm or longer.

ADDITIONAL TRVS



Chrome Straight UIN 331010
 White straight UIN 331008
 Chrome Angle UIN 331009



White Angle UIN 331007
 Antique Brass UIN 263060
 Brushed Nickel UIN 263061

10mm Push Fit Elbow UIN 145341

VERTICAL ULTRA TOWEL RAIL BAR



400mm UIN 83200004
 500mm UIN 83200005
 600mm UIN 83200006
 Maximum of three bars.

ULTRA TOWEL RAIL BAR



400mm wide UIN 83100004
 600mm wide UIN 83100006
 800mm wide UIN 83100008
 1000mm wide UIN 83100010
 Maximum of one bar.

CENTRE TAP TRV

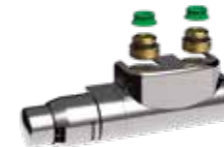

UIN	Elements
14531310	CENTRE TAP TRV STRAIGHT WHITE -10MM
14531312	CENTRE TAP TRV STRAIGHT WHITE -1/2IN
14531315	CENTRE TAP TRV STRAIGHT WHITE -15MM
14531410	CENTRE TAP TRV STRAIGHT CHROME -10MM
14531412	CENTRE TAP TRV STRAIGHT CHROME -1/2IN
14531415	CENTRE TAP TRV STRAIGHT CHROME -15MM
14531510	CENTRE TAP TRV ANGLED L WHITE -10MM
14531512	CENTRE TAP TRV ANGLED L WHITE -1/2IN
14531515	CENTRE TAP TRV ANGLED L WHITE -15MM

UIN	Elements
14531610	CENTRE TAP TRV ANGLED L CHROME -10MM
14531612	CENTRE TAP TRV ANGLED L CHROME -1/2IN
14531615	CENTRE TAP TRV ANGLED L CHROME -15MM
14531710	CENTRE TAP TRV ANGLED R WHITE -10MM*
14531712	CENTRE TAP TRV ANGLED R WHITE -1/2IN*
14531715	CENTRE TAP TRV ANGLED R WHITE -15MM*
14531810	CENTRE TAP TRV ANGLED R CHROME -10MM*
14531812	CENTRE TAP TRV ANGLED R CHROME -1/2IN*
14531815	CENTRE TAP TRV ANGLED R CHROME -15MM*

Available for the Compact Vertical Line Vertical, Compact Flat Vertical, Caliente Rail,* Concord Rail,* Vertical Ultra, Concord Side Concept, Concord Side Chrome, Compact Vertical Line Vertical Concept & Compact Flat Vertical Concept.

*Angled Right Centre Tap TRVs only available for towel rails.

OUR CUSTOMERS LOVE US

Rated 'Excellent' on  Trustpilot



Great looking product which gives off a lot of heat. The single panel version is very snug against the wall so looks really good once installed.
@David



The website was easy to use. The item ordered on a Thursday was delivered the following Monday.
@Brian



Speedy and professional service. Easy installation, quality product in every sense. Heats the room a treat.
@Paul



Prompt delivery, item exactly as expected, well wrapped and secured.
@Jon



First Class company, all round brilliance in every aspect!!
@Paul



Good advice from Stelrad's support team resulted in the correct replacement part being supplied. Service was polite and speedy, thank you.
@SR



Excellent product.
@Tony



Great service. I will certainly buy from Stelrad in the future.
@Brenda



Excellent radiator, well made and very efficient.
@Dave



Service and delivery were first class, radiators well packed to prevent damage all in all a first class experience.
@Alan



Use #Stelrad and mention @Stelrad so we can feature you in future marketing material



Great looking radiators. They are solid and well made.
@Sara





HOME

SERIES



Keep in touch, call us on
0800 876 6813 or email
Sales@Stelrad.com

Follow us on



Stelrad Limited, Stelrad House, Marriott Road, Mexborough, South Yorkshire, S64 8BN

www.stelrad.com

UIN: 20422 Code: SHS/PDF/0125

