



HOME

SERIES



BRINGING RADIATOR STYLE INTO UK HOMES

WELCOME

Your home is not just a house, it's a way for you to show your creativity and personality, creating a space that's both beautiful and practical.

Radiators give you the chance to do just that, bringing unique designs and finishes which can help your home stand out and give visitors an insight into who you really are.

Whether you're looking for super modern or traditional radiators in White, Anthracite grey or colour, our radiators are a great way to add style to your home.

But first, we are here to help you choose from the vast range.

You will also be able to find useful tips to help you find the right size – plus a handy Jargon Buster on page 15 to help you get started.

If you have any questions on which radiators will be the perfect fit for your home, our friendly Customer Services and Technical Team are just a phone call away on freephone 0800 876 6813.

Our website at www.stelrad.com is available for you to order colour samples, or you can use the free Stelrad 3D app to help you visualise a Stelrad product in your home.

Together we will make radiators easy and ensure you find 'the one' for you.



The UK's No.1 Radiator Brand



Beauty in black and white
See page 24

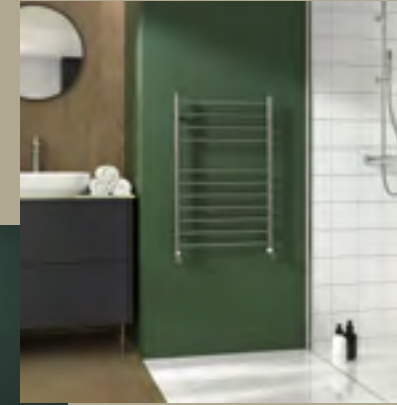

Lecco exclusive to Stelrad Group plc



Making the most of your space
See page 90

See page 90



Chrome and metallic stylish finishes
See page 98

See page 98

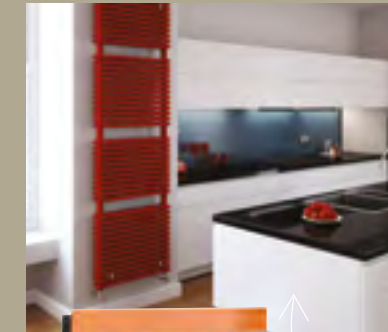

Adding a splash of colour
See page 50

See page 50

CONTENTS

Home Series Radiators

Classic Compact

Classic Compact	16
Classic Compact Xtra Protection	18
Classic Compact Vertical	20
Classic Compact K3	22

Vertical Line

Vertical Line	26
Vertical Line Concept	28
Vertical Line Vertical	30
Vertical Line Vertical Concept	32

Horizontal Line

Horizontal Line	34
Horizontal Line Concept	36

Low Surface Temperature

LST Standard Horizontal Line	38
LST i Plus Horizontal Line	40

Flat

Flat	42
Flat Concept	44
Flat Vertical	46
Flat Vertical Concept	48

Concord

Concord Lo-line Coloured	52
Concord Plane	54
Concord Plane Coloured	56
Concord Vertical	58
Concord Vertical Concept	60
Concord Vertical Coloured	62
Concord Chrome Vertical	64
Concord Slimline	66
Concord Slimline Concept	68
Concord Slimline Coloured	70

Column

Column Horizontal	72
Column Concept	74
Column Horizontal Coloured	76
Column Vertical	78
Column Vertical Concept	80
Column Vertical Coloured	82
Cast Iron Column	84

Home Series Towel Radiators

Classic Towel Rail

Classic Towel Rail - curved	86
Classic Towel Rail - straight	88
Mini Towel Rail	88

Stainless Steel Towel Rail

Stainless Steel Towel Rail	92
----------------------------	----

Como

Como	94
------	----

Caliente Rail

Caliente Rail	96
---------------	----

Concord Rail

Concord Rail	100
--------------	-----

Concord Side

Concord Side Chrome	102
Concord Side Concept	104

Lecco

Lecco	106
-------	-----

Ultra

Ultra	108
Vertical Ultra	110

Sizes, Heating Specifications	114
-------------------------------	-----

Accessories	142
-------------	-----

Exclusive
to Stelrad
Group plc

Handy hints & tips

Deciding on the right radiator or towel rail	8
---	---

Colour Guide	10
--------------	----

Stelrad 3D App	14
----------------	----

Trending:

Small on space, big on style	90
Making a statement with colour	50
Inspiration in black and white	24
Marvellous metallics	98

Jargon Buster	15
---------------	----

Our Customers love us	144
-----------------------	-----

HOME

SERIES

STELRAD RADIATORS MADE IN THE UK SINCE 1936

It's easy to see why Stelrad Radiators is the UK's number one radiator brand. With a rich heritage in manufacturing high quality, stylish modern radiators since 1936, it's safe to say we know a thing or two about heating.

We understand that purchasing a new radiator can be daunting, which is why our expert research team is dedicated to continually developing innovative products. To widen our extensive range to enable you to choose from the largest selection of technically-advanced radiator styles and sizes in the UK.

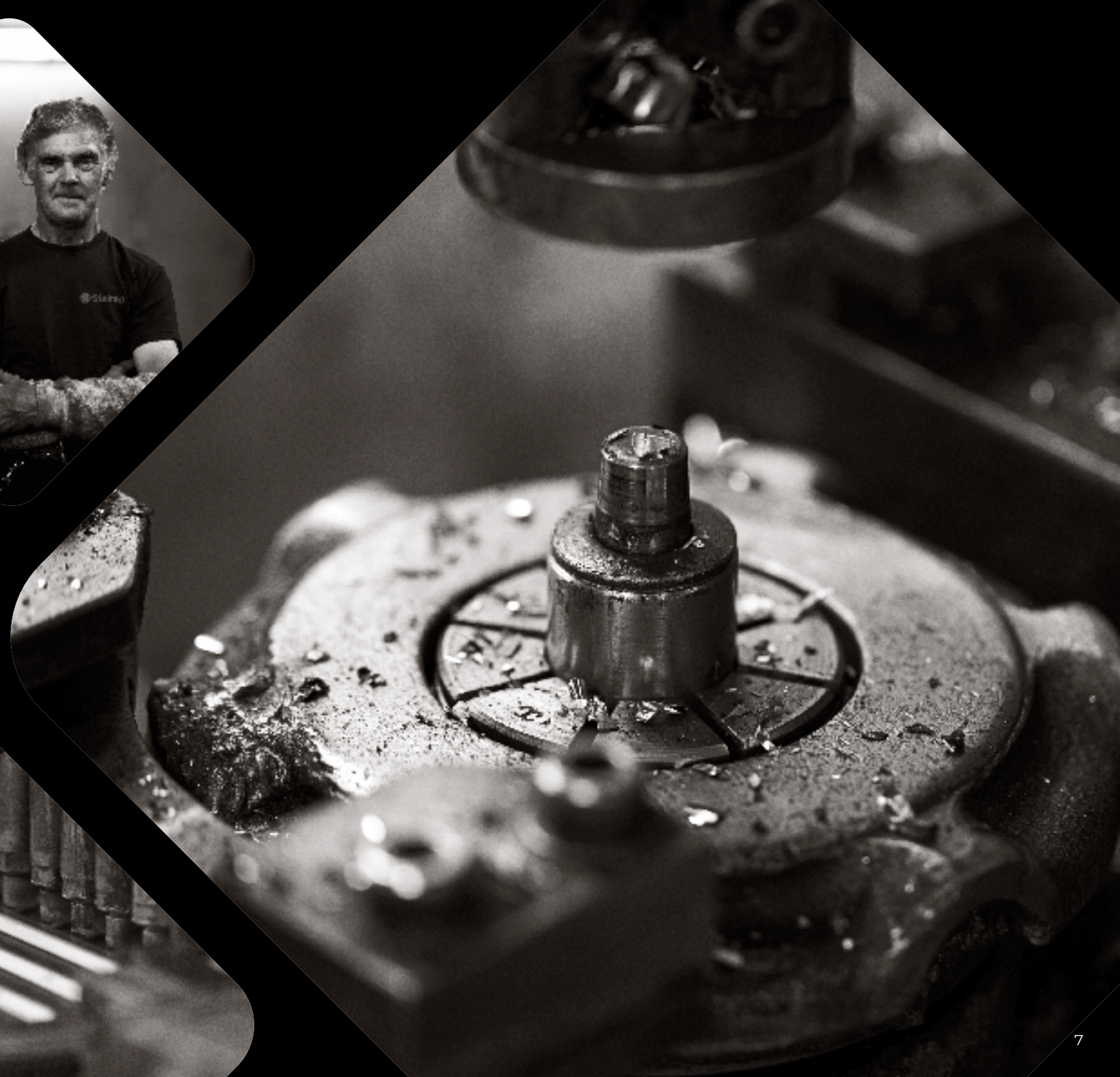

DECIDING ON THE RIGHT RADIATOR OR TOWEL RAIL

Where to start?

You don't have to be limited by the size and style of radiator that you're replacing, there are loads of options to choose from, which will fit with your style and generate the right amount of heat for your room.

In this brochure, we'll take you through what you need to consider when buying your new radiator or towel rail.

How do I choose the right radiator or towel rail?

The first thing you need to do is calculate how much heat you need in your room, using Stelrad's STARS basic or advanced heat loss calculator. Your plumber or installer can help you with heat loss calculations.

Using Stelrad's online heat loss calculator, your plumber or installer can add in the details, such as your room dimensions, window size(s) and wall. The calculator then gives you the required BTUs and Watts you will need to efficiently heat your room to a comfortable temperature.

If it's a large room, you can choose multiple radiators or towel rails within a range to reach the heat you need.

Need help?

Call our friendly Customer Service and Technical Team on freephone **0800 876 6813** or ask us a question using Live Chat on our website.

Consider your room

Use the suitability table to see what options you should choose from.

Room suitability	Bedroom	Hallway	Kitchen	Living Room	Bathroom	Other	Warranty
Horizontal radiators, including lo-line options	Yes	Yes	Yes	Yes	Yes*	Yes	5 – 10 years
Vertical radiators, including panel and tubed options	Yes	Yes	Yes	Yes	Yes*	Yes	5 – 10 years
Column radiators, including Steel and Cast Iron options	Yes	Yes	Yes	Yes	Yes*	Yes	5 – 10 years
Xtra Protection Radiators (ideal for humid rooms – see pg 18 for details)	Yes	Yes	Yes	Yes	Yes	Yes	5 – 10 years
LSTs (a radiator with a cover which doesn't get too hot to touch – see pages 38-40 for details)	Yes	Yes	Yes	Yes	Yes*	Yes	5 – 10 years
Towel Rails		Yes	Yes		Yes	Yes	5 – 10 years

*Horizontal and vertical steel panel radiators, which are installed in high humidity rooms (including bathrooms, kitchens & shower rooms etc...) are limited to a 12-month parts and labour warranty.

Then choose which shape you like:

Radiators:

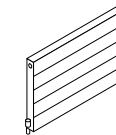

Horizontal

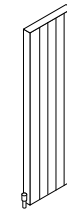

Vertical

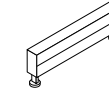

Lo-Line

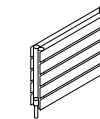

Tubed

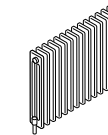

Columns

Towel rails:

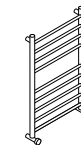

Round tubes

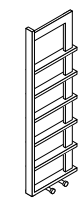

Square tubes



Flat tubes

With this in mind, you can now use the following pages to look at our wide selection of radiators and towel rails.

Once you've selected your product, use pages 114-141 to see what sizes you need to fulfill the heat requirements for your room.

COMPLETE THE LOOK BY CHOOSING YOUR OWN COLOUR

These days you are not limited to a traditional white radiator, you have the freedom to choose the most suitable colour radiator which will complement the colour scheme of your room.



Look out for these swatches

These 'made to order' options have up to an 8 week lead time and once ordered, cannot be cancelled or returned.

To request up to 5 colour samples, please email Sales@Stelrad.com or call **0800 876 6813** with your choices and address details.

The colours shown are reproduced as accurately as printing processes will allow.

COLOUR GUIDE



COLOURS IN STOCK

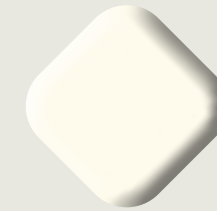

**RAL 9016
Glossy
Traffic White***

Classic, Compact Xtra Protection, Compact Vertical, Compact K3, Vertical Line, Vertical Line Vertical, Horizontal Line, LST Standard Horizontal Line, LST i Plus Horizontal Line, Flat, Flat Vertical, Concord Plane, Concord Vertical, Concord Slimline, Column Horizontal, Column Vertical, Classic Towel Rail.

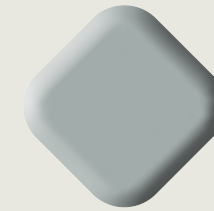

**Brushed
Stainless Steel**

Stainless Steel Towel Rail, Como, Lecco.

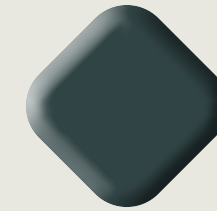

**RAL 7016
Glossy
Anthracite Grey****

Vertical Line Concept, Column Concept, Horizontal Line Concept, Flat Concept, Horizontal Line Vertical Concept, Flat Vertical Concept, Column Vertical Concept, Concord Vertical Concept, Concord Slimline Concept.

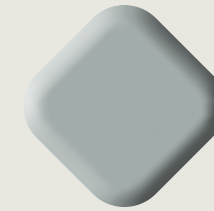

**Polished
Stainless Steel**

Stainless Steel Towel Rail, Lecco.

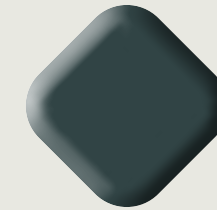

**VOV12
Matt
Anthracite Grey**

Concord Side Concept.

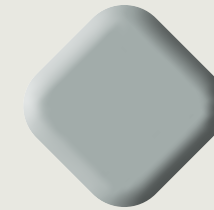

Chrome

Classic Towel Rail, Concord Side Chrome, Concord Chrome Vertical.

*Also available as a made to order colour for the Ultra and Vertical Ultra

**Also available as a made to order colour option for the Caliente Rail, Concord Rail, Ultra and Vertical Ultra.

COLOURS FOR CAST IRON COLUMN, CALIENTE RAIL, CONCORD RAIL, ULTRA & VERTICAL ULTRA



GLOSSY FINISHES (SMOOTH)



MATT FINISHES (SMOOTH)



METALLIC FINISHES (SMOOTH)



NATURAL CAST

METALLIC FINISHES (TEXTURED)



Please note on the Ultra and Vertical Ultra only the front fascia panel can be coloured. Where the product is 1000mm or 1200mm, the emitter, top grille and side panels are black. If the product is 1800mm or 2000mm the emitter, top grille and side panels are white.

COLOURS FOR COLUMN COLOURED & CONCORD COLOURED



RAL COLOURS



METALLIC COLOURS



SEE BEFORE YOU TRY WITH OUR STELRAD 3D APP





The app that helps you choose the right radiator for your space

If you want to see what a radiator or towel rail looks like in your room, use the free app and see instantly how different styles and sizes transform your space.

The Stelrad 3D app can be downloaded from your App Store for Apple and Google Play Store for Android phones by searching for Stelrad 3D.



JARGON BUSTER

Btu/hr	British Thermal Unit per hour is the standard measurement used to state the amount of output of any heat generating device.
Δt	Refers to the difference in temperature between the water circulating in the central heating system and that of the ambient temperature. It is important to use the correct Δt when selecting your radiators, as the same radiator will have different outputs at different water temperatures.
Δt_{50}	Δt_{50} is the UK standard, however Stelrad also quote at lower levels for lower water temperature systems.
Heat loss	Heat loss is the amount of heat a room loses, it is therefore an important calculation when determining what size radiator is required to heat a room to the correct level.
K1	Also known as Type 11, is a type of radiator with 1 radiator panel and 1 set of convection fins. 
K2	Also known as Type 22, is a type of radiator with 2 radiator panels and 2 sets of convection fins. 
K3	Also known as Type 33, is a type of radiator with 3 radiator panels and 3 sets of convection fins. 
P+	Also known as Type 21, is a type of radiator with 2 radiator panels and 1 set of convection fins. 
P2	Also known as Type 20, is a type of radiator with 2 radiator panels and no convection fins. 
RAL	A European wide colour matching system.
UIN	Is the unique identification number for Stelrad products.
Warranty	The warranty covers any defect that is attributable to a manufacturing, assembly or material fault. Further details available on request.
Watts	Is another measurement for heat output.



Classic Compact

The Stelrad Home Series Classic Compact is one of the most popular ranges and looks at home in any interior setting.

400mm - 2400mm

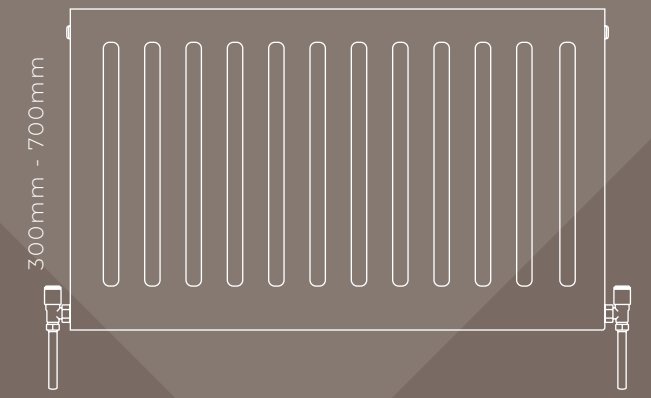

✓
IN STOCK

10
YEAR
WARRANTY



Only available
in Traffic White

Classic Compact Xtra Protection

The Stelrad Home Series Classic Compact Xtra Protection radiator is perfect for bathrooms, showers or wet rooms with its zinc coating.

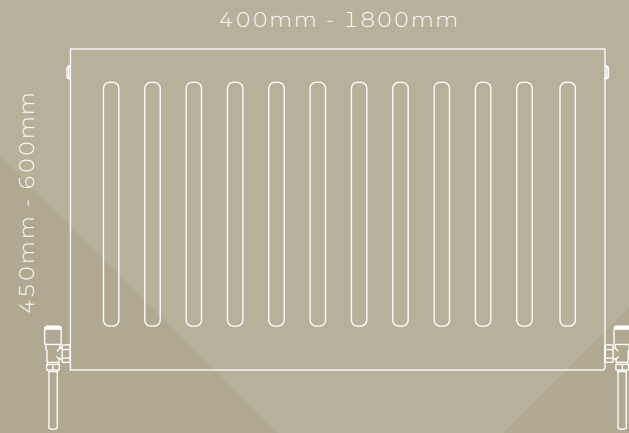

Only available
in Traffic White



5
YEAR
WARRANTY



IN STOCK



Classic Compact Vertical

The Stelrad Home Series Classic Compact Vertical offers a smart, stylish look with excellent performance.

400mm - 600mm

18000mm

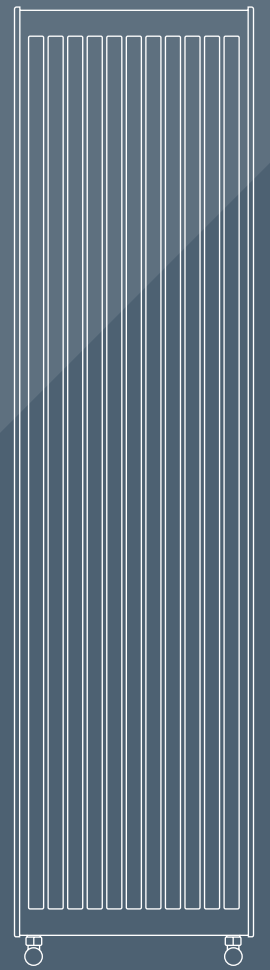

✓
IN STOCK

10
YEAR
WARRANTY



Only available
in Traffic White

Classic Compact K3

Ideal for where a high heat output is required or to be paired with low temperature heating systems, that's the Stelrad Home Series Classic Compact K3.

Range extension

400mm - 1400mm

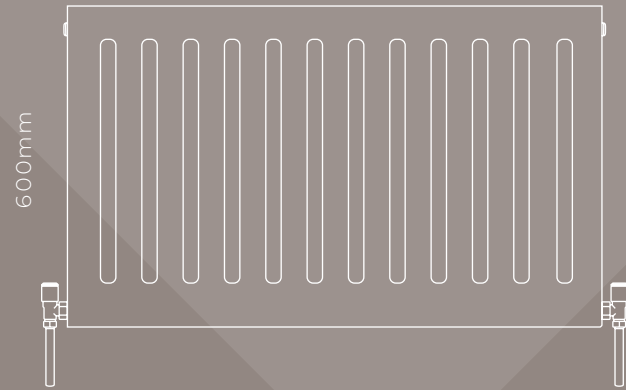

Only available
in Traffic White



10
YEAR
WARRANTY



INSPIRATION IN BLACK AND WHITE

Concord Vertical

See page 58.

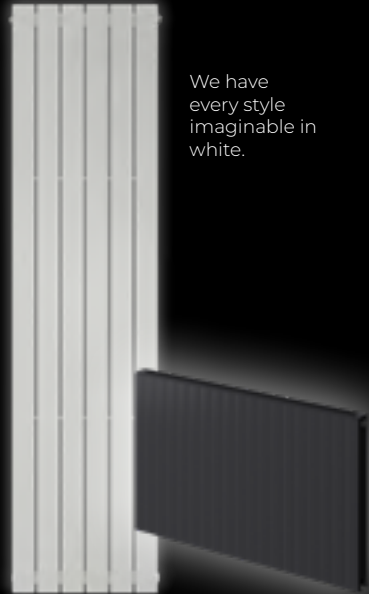

We have every style imaginable in white.

The Vertical Line Concept in Anthracite grey is a great choice for this trend. See page 28.

Black and white can be just as quirky and personal as more colourful decors, a primary colour scheme lends itself to an elegant and contemporary finish. Rather than lacking in vibrance, it provides the perfect backdrop for just a few hints of an accent shade, should you wish to add one.



Metallic radiators look great in a monochrome setting

The Como stainless steel radiator works really well in a monochrome setting, adding a dash of luxury. See page 94.

Column Horizontal - see page 72.



Sometimes forgoing colour for a classic palette can really pay off, and this black and white bathroom is proof. A modern design is sure to inspire your own space.

Vertical Ultra - Graphite black

See page 110.





Range extension

Vertical Line

The Stelrad Home Series Vertical Line adds a strong, bold appeal to an already attractive designer radiator.

400mm - 2000mm

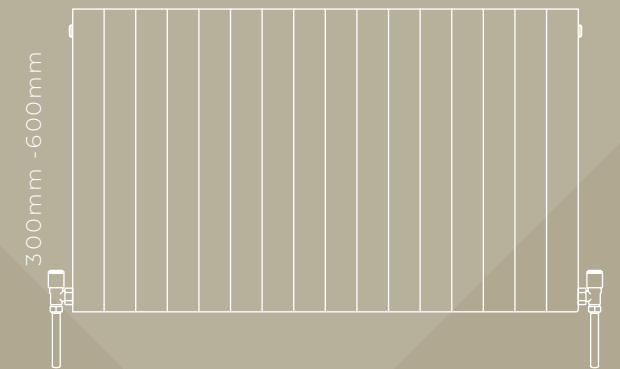

✓
IN STOCK

10
YEAR
WARRANTY

Only available
in Traffic White

Vertical Line Concept

The Stelrad Home Series Vertical Line Concept in Anthracite grey adds a modern feature to any room.

Range extension

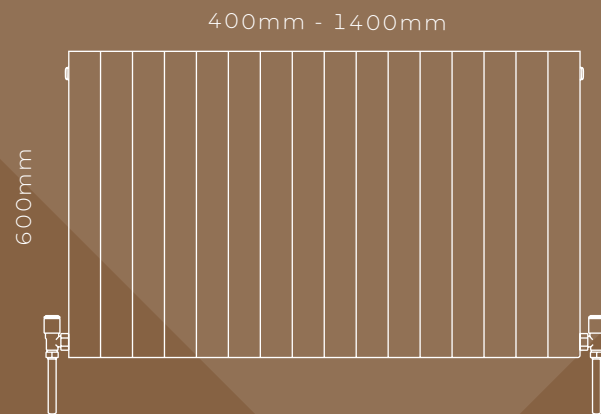

Only available
in Anthracite grey



10
YEAR
WARRANTY



IN STOCK



Vertical Line Vertical

The Stelrad Home Series Vertical Line Vertical is an attractive slim vertical radiator option, featuring an elegant lined front face, adding style to any modern home.

Elegant lines for an elegant look

400mm - 600mm

1800mm

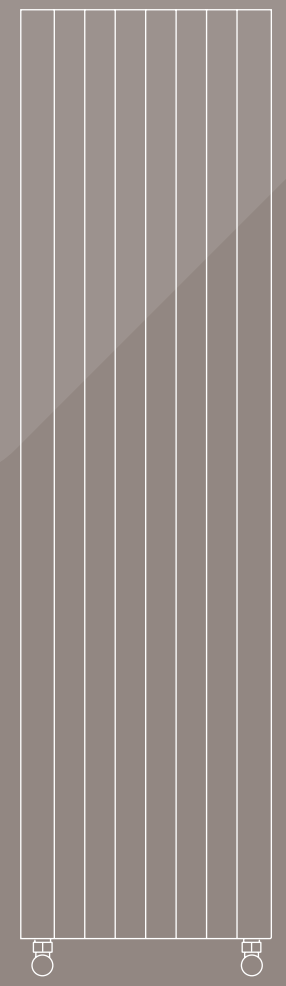

 IN STOCK

10
YEAR
WARRANTY



Only available in Traffic White

Vertical Line Vertical Concept

The Stelrad Home Series Vertical Line Vertical Concept, features a fashionable vertical lined front face in the popular Anthracite grey.

400mm - 600mm

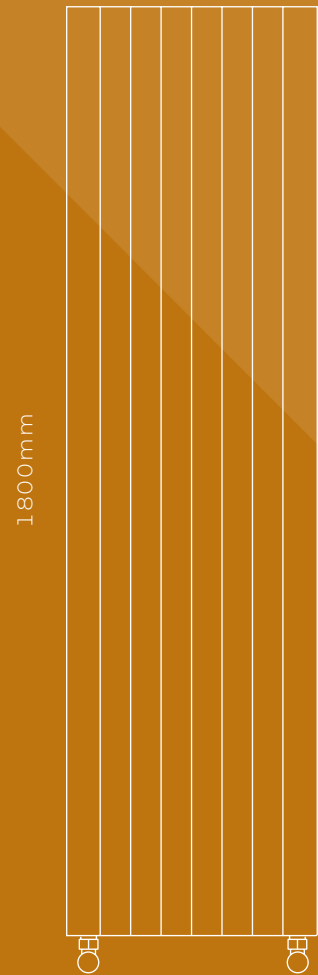

Only available
in Anthracite grey



10
YEAR
WARRANTY



IN STOCK





Range extension

Horizontal Line

The sleek lines of the Home Series Horizontal Line make it an easy choice when looking for a designer radiator.

400mm - 2000mm

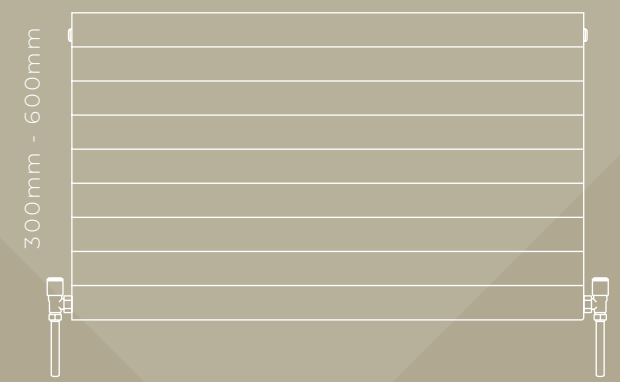

IN STOCK

10 YEAR WARRANTY



Only available in Traffic White

Horizontal Line Concept

The Stelrad Home Series Horizontal Line Concept in Anthracite grey adds a cool and contemporary fashion statement that'll complement any choice of décor.

Range extension



The Anthracite grey looks great with a neutral palette



Only available in Anthracite grey



10 YEAR WARRANTY



IN STOCK



LST Standard Horizontal Line

The Stelrad Home Series LST Standard Horizontal Line radiators are the Low Surface Temperature safe heating option for your home.

560mm - 1960mm

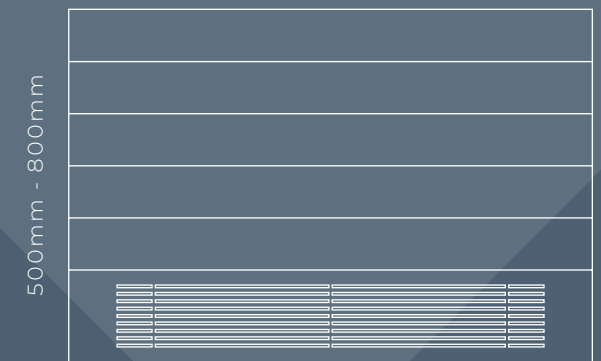

10
YEAR
WARRANTY
(EMITTER)

5
YEAR
WARRANTY
(CASING)



Only available
in Traffic White

LST i Plus Horizontal Line

The Stelrad Home Series LST i Plus Horizontal Line is a safety must have. Offering high heat output but safe to touch, with an aesthetically pleasing lined front.

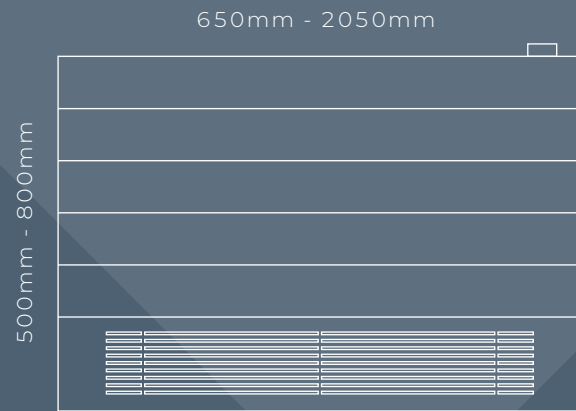

10
YEAR
WARRANTY
(EMITTER)

5
YEAR
WARRANTY
(CASING)

MADE TO ORDER

SAFE TO TOUCH

Only available in Traffic White





Flat

The Stelrad Home Series Flat radiator features a stunning, simplistic finish and a smooth flat face making it the ultimate in minimal design.



10
YEAR
WARRANTY



Only available
in Traffic White

Flat Concept

The Stelrad Home Series Flat Concept offers a minimalist design which is complemented by the elegance of its Anthracite grey finish.



Only available
in Anthracite grey



10
YEAR
WARRANTY



IN STOCK



Flat Vertical

The Stelrad Home Series Flat Vertical is a popular vertical radiator that adds minimalist style to complement any room.

400mm - 600mm

1800mm

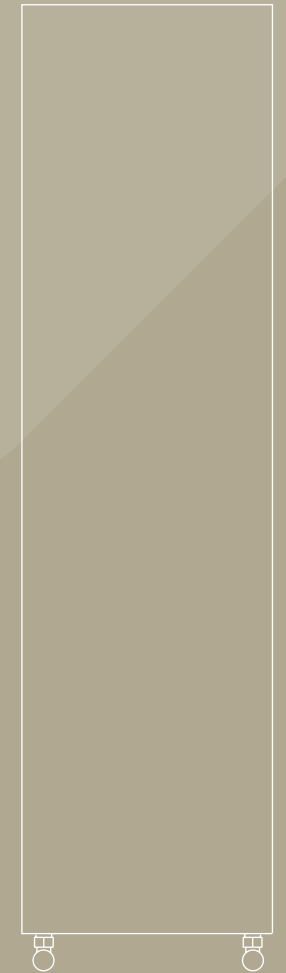

10
YEAR
WARRANTY



Only available
in Traffic White

Flat Vertical Concept

The Stelrad Home Series Flat Vertical Concept has a sleek and simplistic finish in the dignified Anthracite grey, making this a popular choice to complement any décor.

400mm - 600mm

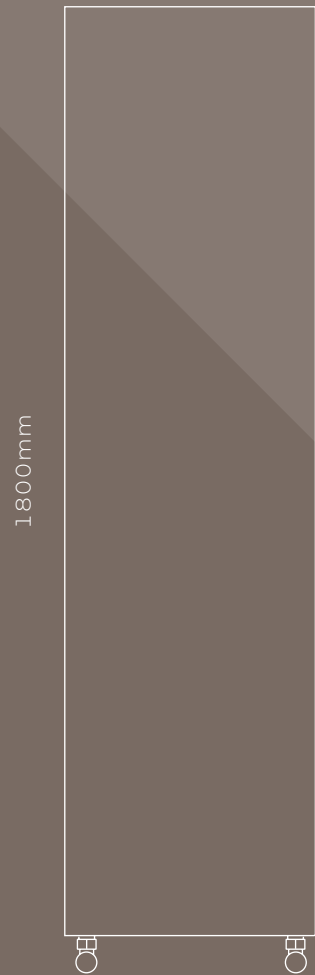

Only available
in Anthracite grey



10
YEAR
WARRANTY



IN STOCK



MAKING A STATEMENT WITH COLOUR

One of the most impactful ways to make a statement is with colour... and it is so on trend. Whether it's a hint of colour or a bold statement with a lot of colour, this is one of the most versatile ways of reflecting your personality and setting the mood you desire.

Ultra in Pale blue

The bespoke Ultra is a modern designer radiator with optional towel rail bars, which comes in a whole range of colours - see page 108.



Concord Side Concept

Comes in a matt finish Anthracite grey and is a flat tubular design with piping at one side giving a sleek, stylish look to any room - see page 104.

Beautiful Cast Iron Column

Available in Natural Cast. See page 84.

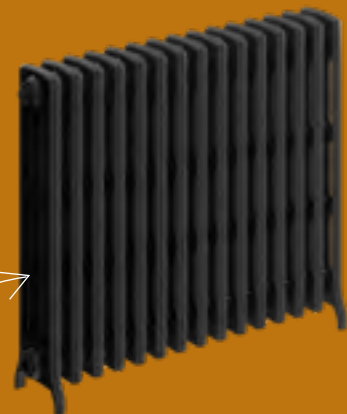

Look out for these colour swatches on the product pages and view the colour chart on pages 12-13.

Concord Rail in Carmine Red

See page 100.

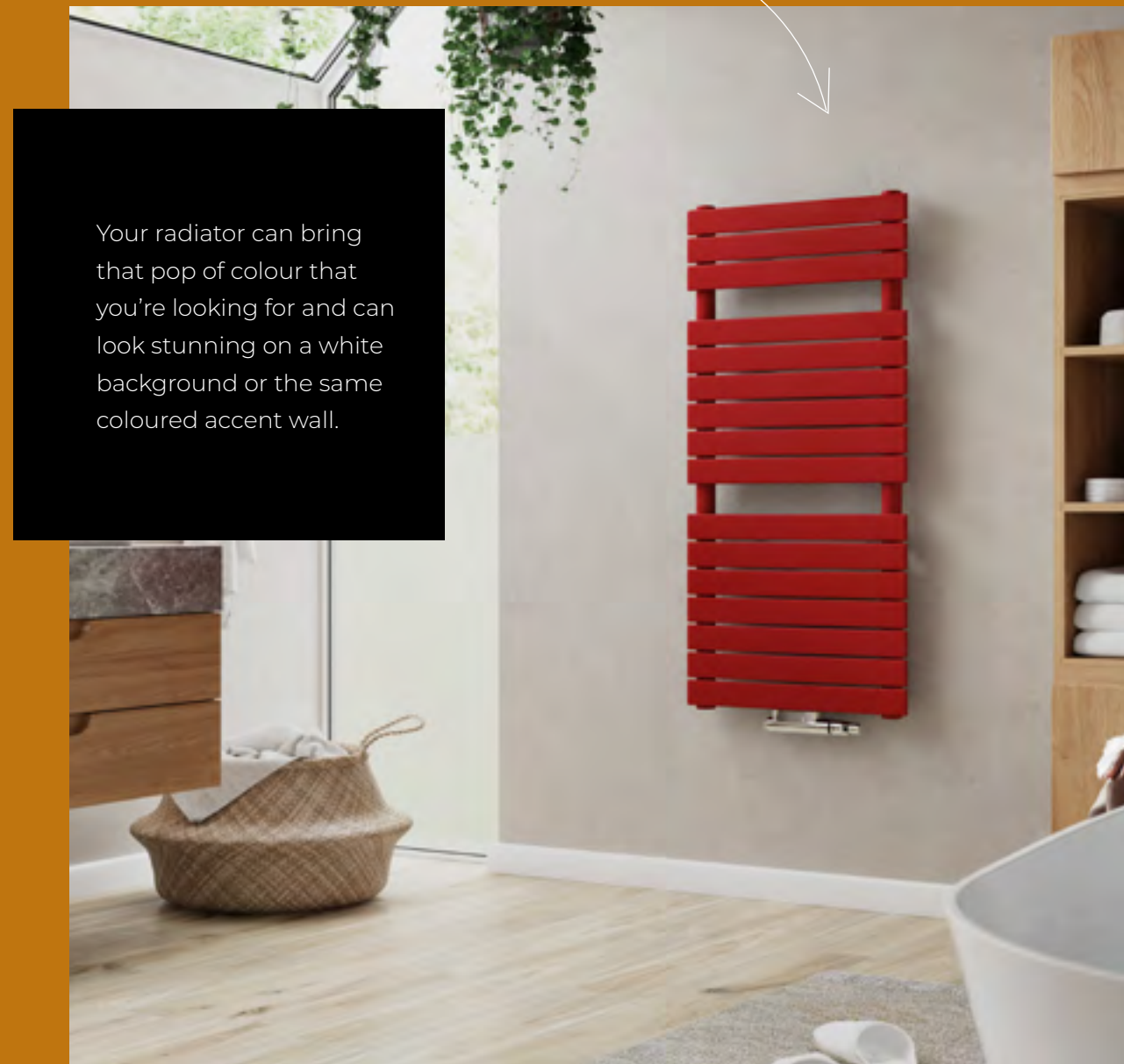

Your radiator can bring that pop of colour that you're looking for and can look stunning on a white background or the same coloured accent wall.



Concord Lo-Line Coloured

Conveniently designed to squeeze into small spaces in your home, the Stelrad Home Series Concord Lo-Line Coloured has it all.

800mm - 2200mm

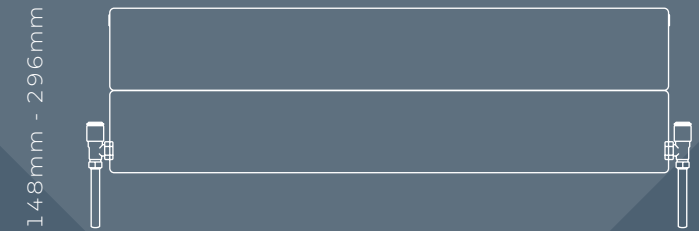

Pastel green



Colour options available.
See pages 10 & 11.

Concord Plane

The Stelrad Home Series Concord Plane offers a contemporary, modern way to heat your room.

500mm - 1400mm

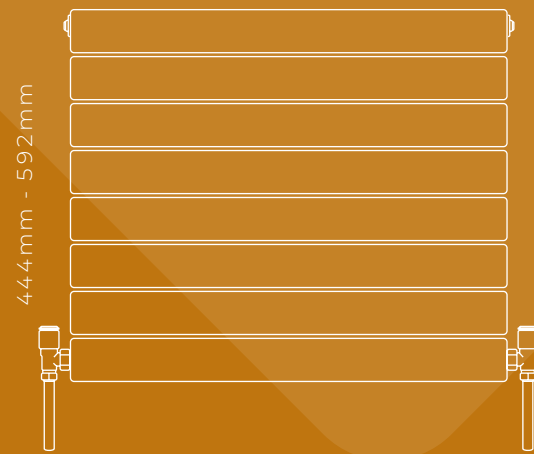

Only available
in Traffic White



5
YEAR
WARRANTY



IN STOCK



Concord Plane Coloured

Available in an abundance of colour options the Stelrad Home Series Concord Plane Coloured gives you the ability to amplify your home with whatever colour palette you choose.

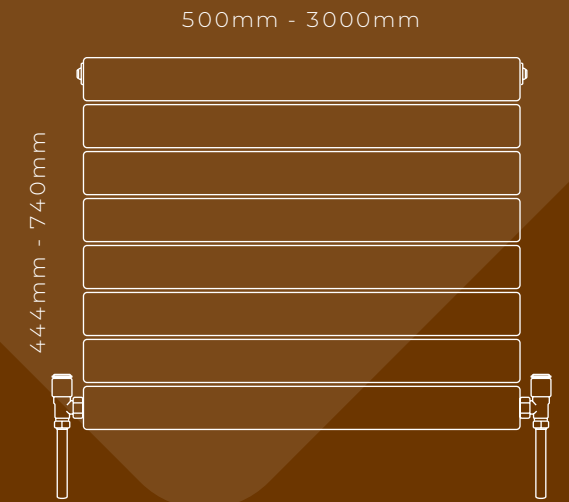

Colour options available.
See pages 10 & 11.

Golden yellow

Concord Vertical

The Stelrad Home Series Concord Vertical is visually appealing and constructed from slim, flat tubes.

444mm - 740mm

1800mm - 2000mm

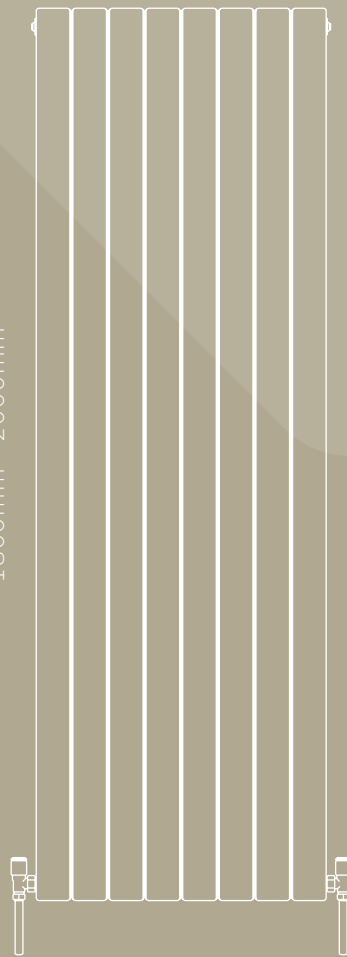

Only available
in Traffic White



5
YEAR
WARRANTY





Concord Vertical Concept

The Stelrad Home Series Concord Vertical Concept in Anthracite grey shows off the slim, flat tubes of this beautiful radiator.

444 mm - 740 mm



Only available in Anthracite grey

Concord Vertical Coloured

Offering an array of over 30 colour options, the Stelrad Home Series Concord Vertical Coloured can be suited to any décor.

444mm - 740mm

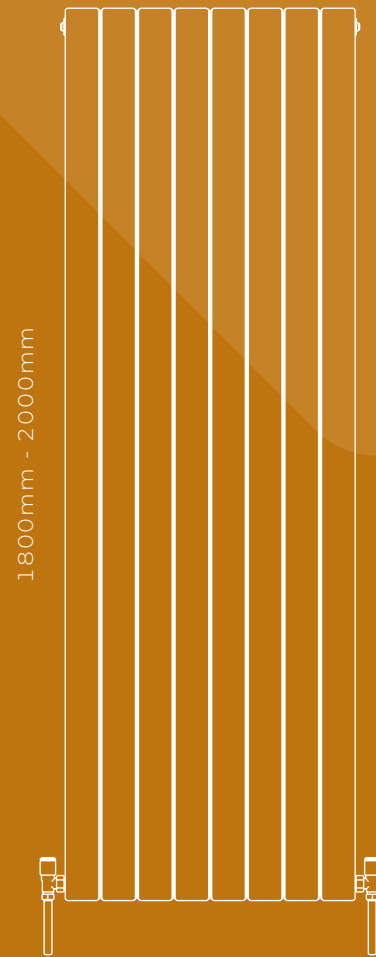

Colour options available.
See pages 10 & 11.



Golden yellow



Concord Chrome Vertical

The Stelrad Home Series Concord Chrome Vertical is a stunning, minimalist vertical flat panel designer radiator in a modern, eye-catching mirror Chrome finish.

310mm - 604mm

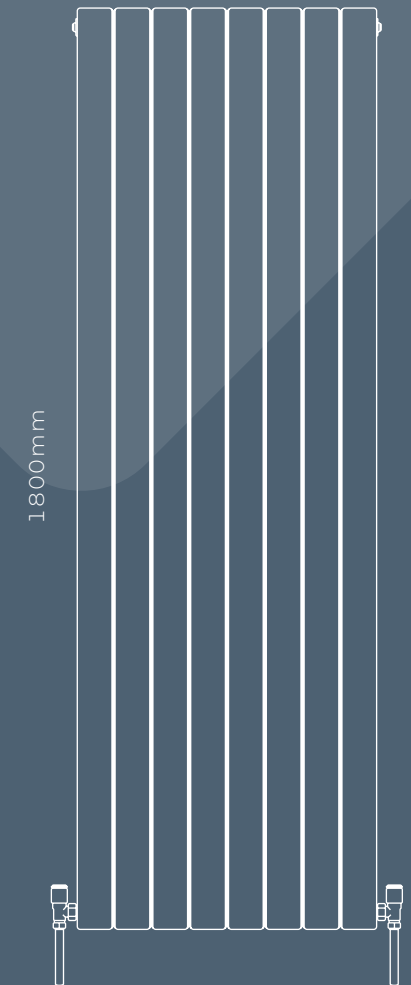

1800mm



5
YEAR
WARRANTY



Only available
in Chrome

Concord Slimline

The Stelrad Home Series Concord Slimline radiator is fashionable, with slim vertical flat panel tubing to maximise the space in your room.

320mm - 640mm

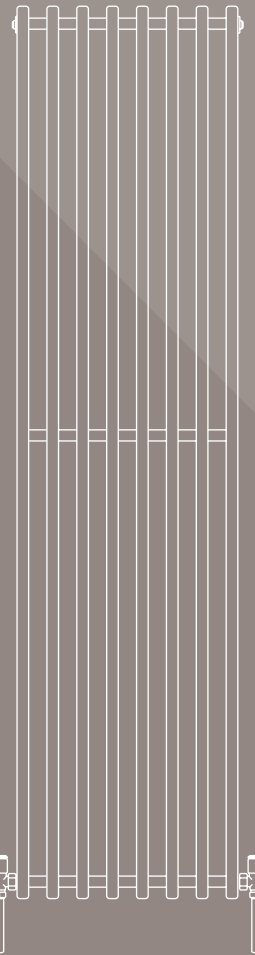

1800mm - 2000mm

Only available
in Traffic White



5
YEAR
WARRANTY



IN STOCK





Concord Slimline Concept

The Stelrad Home Series Concord Slimline Concept radiator in Anthracite grey makes a statement and maximises space in your room, without compromising on output.

320mm - 640mm

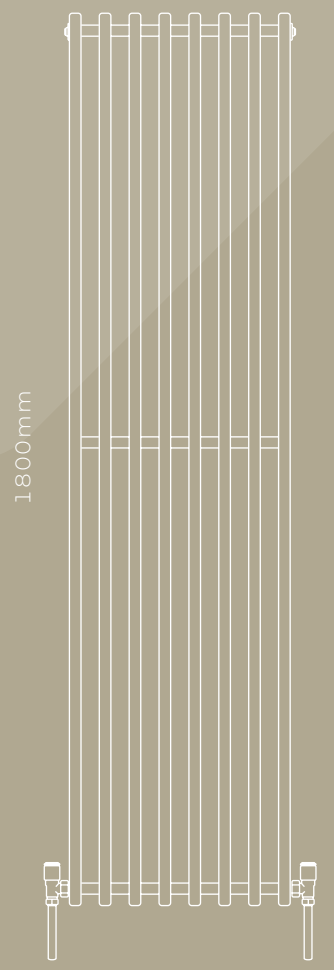

1800mm



Only available in Anthracite grey

Concord Slimline Coloured

The slim and stylish tubed design of the Stelrad Home Series Concord Slimline Coloured is available in over 30 colours.

320mm - 640mm

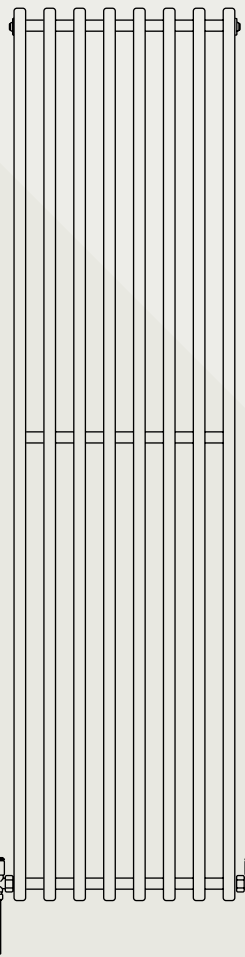

1800mm - 2000mm

Colour options available.
See pages 10 & 11.



Pastel blue



Column Horizontal

The Stelrad Home Series Column Horizontal is perfectly designed for all interiors whether it's contemporary or traditional.

444mm - 1870mm

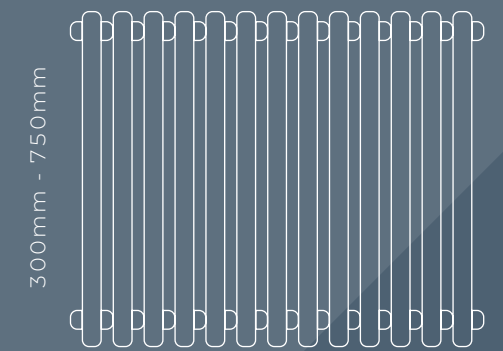

5
YEAR
WARRANTY



Only available
in Traffic White

Column Concept

Add a little colour to your home with the Stelrad Home Series Column Concept in Anthracite grey, the ultra-modern version of the retro Column radiator.

628mm - 1272mm

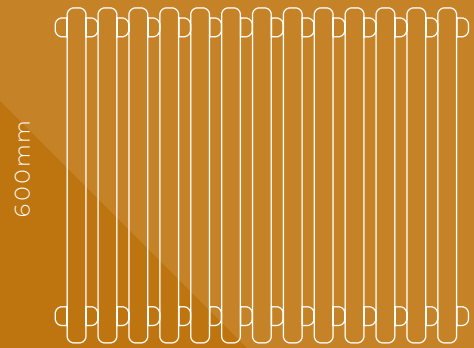

Only available
in Anthracite grey



5
YEAR
WARRANTY





Column Horizontal Coloured

The Stelrad Home Series Column Horizontal Coloured has colour options to harmonise with the boldest or most neutral of decors.

444mm - 1870mm

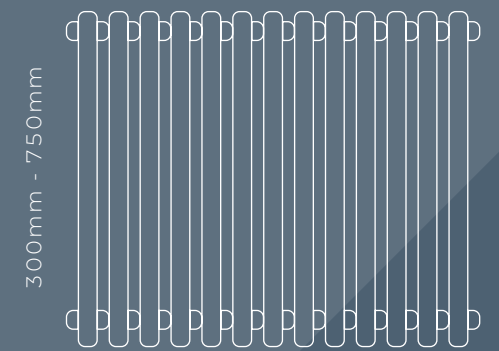

Turquoise blue



Colour options available.
See pages 10 & 11.

Column Vertical

The Stelrad Home Series Column Vertical provides a real style statement. Ideal for use in modern, minimalist rooms or where wall space is restricted.

352mm - 444mm

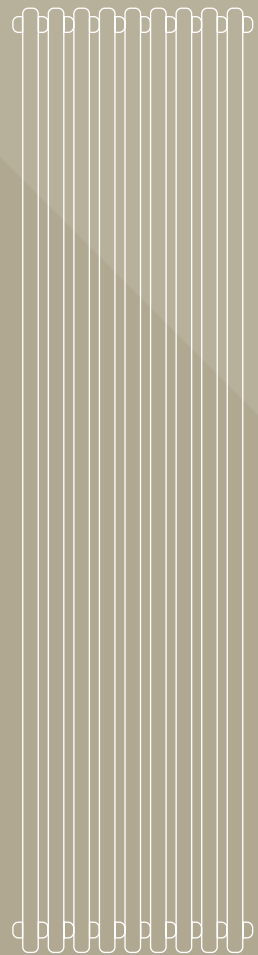

1800mm - 2500mm

Only available
in Traffic White



5
YEAR
WARRANTY



IN STOCK





Column Vertical Concept

The Stelrad Home Series Column Vertical Concept is a contemporary twist on the retro column radiator. Make a bold statement in your room with this Anthracite grey vertical column.

444mm

1800mm - 2000mm

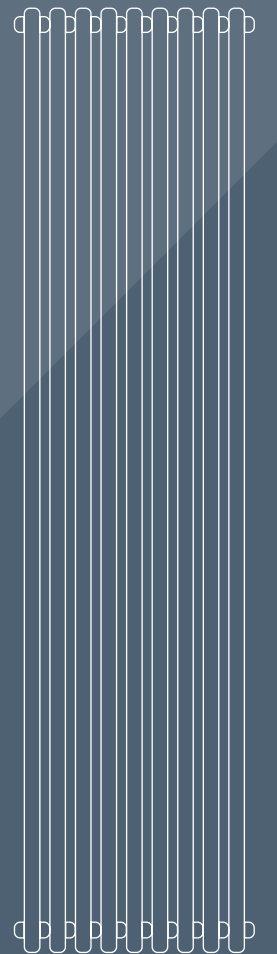

Only available
in Anthracite grey

Column Vertical Coloured

Offering a chic solution that can accentuate the use of traditional materials and enhance a contemporary or period appearance, the Stelrad Home Series Column Vertical Coloured is the perfect choice.

352mm - 444mm

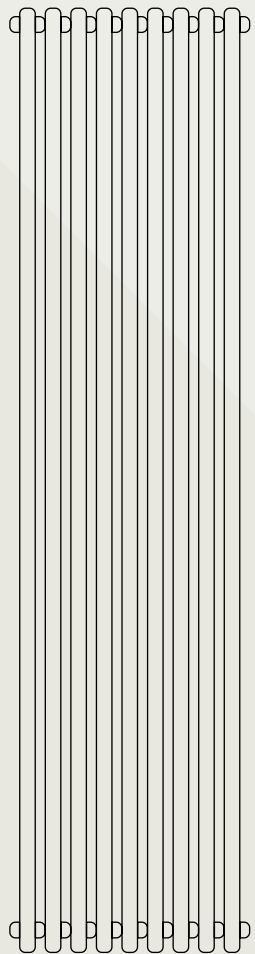

1800mm - 2500mm

Colour options available.
See pages 10 & 11.



Bronze metallic





Range extension

Cast Iron Column

The stylish Home Series Cast Iron Column radiator has the classic clean lines of a column. Its elegant design means that it is a popular choice and well suited for either a modern or period home setting.

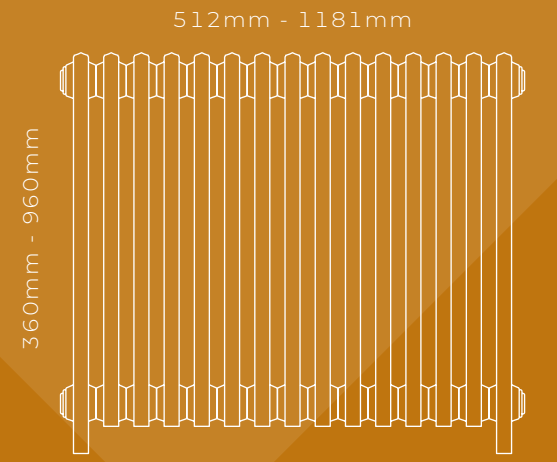

10
YEAR
WARRANTY



Only available
in Natural Cast

Classic Towel Rail - Curved

The curved version of the Stelrad Home Series Classic Towel Rail provides effective heating and practical drying performance for any kitchen or bathroom. It benefits from 25mm round tubes for a higher heat output.

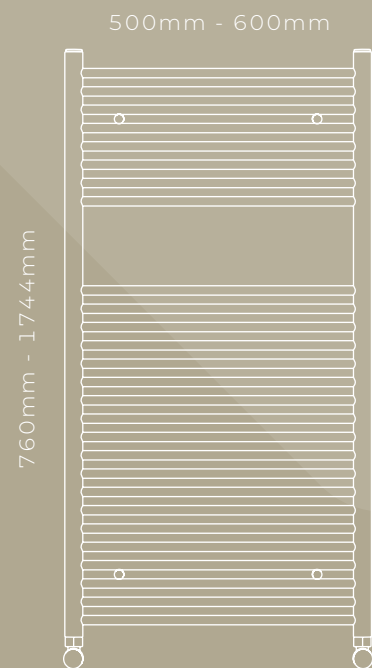

Only available in
Traffic White or Chrome



5
YEAR
WARRANTY





Classic Towel Rail - Straight

The straight version of the Stelrad Home Series Classic Towel Rail provides effective heating and practical drying performance for any kitchen or bathroom. It benefits from 25mm round tubes for a higher heat output.

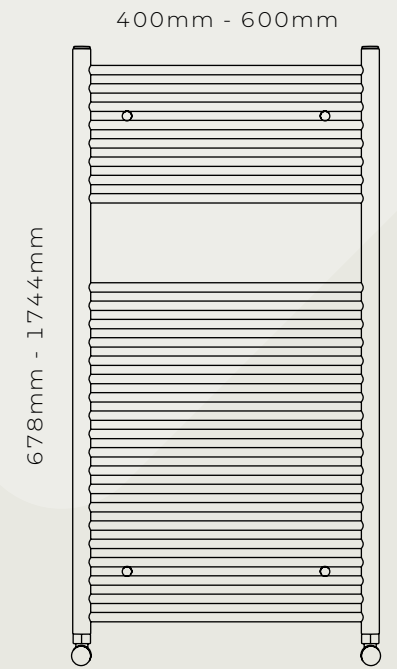

Mini Towel Rail size 678mm x 400mm



Only available in
Traffic White or Chrome

SMALL ON SPACE, BIG ON STYLE

Nowadays there are so many ways to make the most of small spaces. Clever storage options and smart finishes mean that even the smallest of bathrooms or kitchens can be stylish as well as practical. Whether you opt for a sleek streamlined look, or traditional detailing, there are plenty of ways to make your space stylish, practical and, with the right know-how, space efficient.

Concord Rail

This radiator not only warms your towels but also looks great in a bathroom.

See page 100.



Como.
See page 64.



Concord Slimline

Sometimes a narrow space fits a thinner vertical rail better.

See page 66.

Concord Lo-Line Coloured

See page 52



Stainless Steel Towel Rail with polished steel finish.
See page 92.

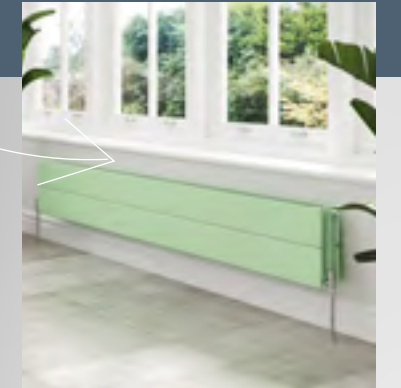

Mini Classic Towel Rail

with 25mm tubes for high heat output, see page 88.

Stainless Steel Towel Rail

The Stelrad Home Series Stainless Steel Towel Rail in its brushed or polished finish, not only warms your towels but also looks great in a kitchen or bathroom.

500mm - 600mm

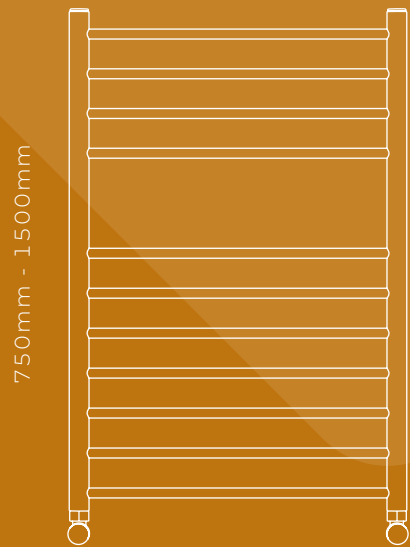

Available in Brushed Stainless Steel or Polished Stainless Steel



5
YEAR
WARRANTY



Brushed steel

A Brushed or Polished finish looks great in the kitchen or bathroom





Como

The Stelrad Home Series Como is a stylish towel rail with flat brushed stainless-steel rectangular tubes to create a modern, contemporary look in any bathroom or kitchen.

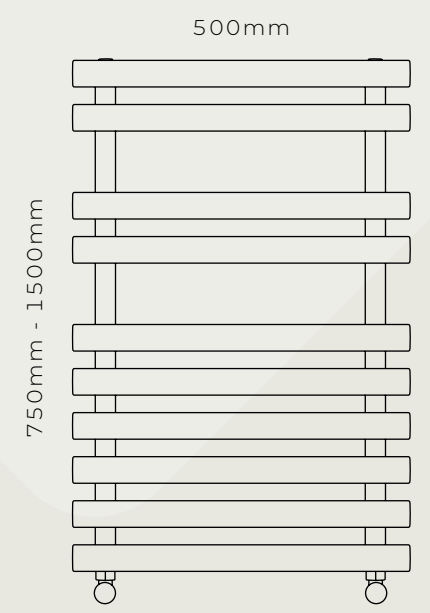

 IN STOCK

5
YEAR
WARRANTY

 Only available in
Brushed Stainless Steel

Caliente Rail

The Stelrad Home Series Caliente Rail is a hugely popular tubular option, it's an easy choice for any bathroom or kitchen and any interior setting whether it's a modern, contemporary or period interior. It benefits from 22mm round tubes for a higher heat output.

450mm - 750mm

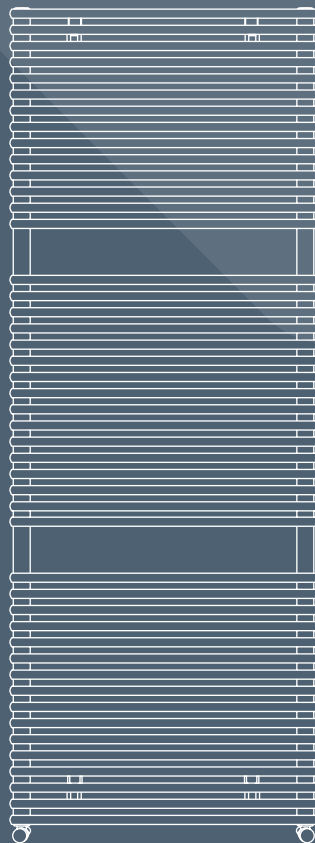

755mm - 2013mm

Colour options available.
(Made to Order)
See pages 10 & 11.



TRAFFIC WHITE



Your radiator can bring that pop of colour that you're looking for



Ultramarine blue

MARVELLOUS METALLICS

Get involved with the trend that is taking the world by storm; metallic finishes. From chrome to brass, stainless steel to copper and everything in between, you can't hide from these finishes adorning the pages of your favourite interior magazines. The high shine surface of chrome exudes luxury and is suited to all home decor styles, especially modern interiors.



Classic Towel Rail - Straight

with 25mm tubes for high heat output, see page 88.

Exclusive to Stelrad Group plc

Lecco
A stunning combination of brushed and polished steel finishes. See page 106.



Concord Side Chrome

Oozes functionality and style with its stunning chrome finish. See page 102.

Metallics are super hardwearing and perfect for busy family life, whilst remaining stylish and eye-catching.

Concord Chrome Vertical

See page 64.



Concord Rail

The Stelrad Home Series Concord Rail offers a stunning alternative to tubular towel rails with flat tube on tube and will enhance any kitchen or bathroom. Available in a range of colours making it simple to match and contrast colour schemes.

450mm - 600mm

731mm - 1771mm

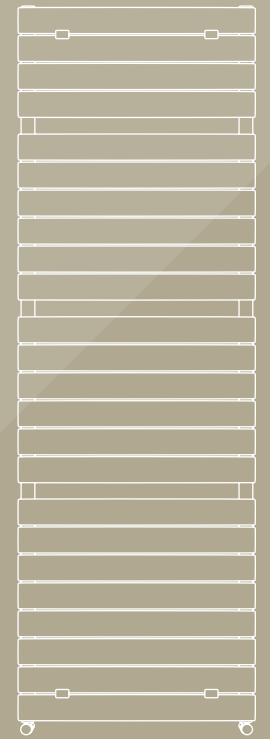

TRAFFIC WHITE



Colour options available.
(Made to Order)
See pages 10 & 11.

Concord Side Chrome

The Stelrad Concord Side Chrome oozes functionality and style with its stunning chrome finish. Gone are the days when towel rails were merely a heating device, they are now a design feature too.

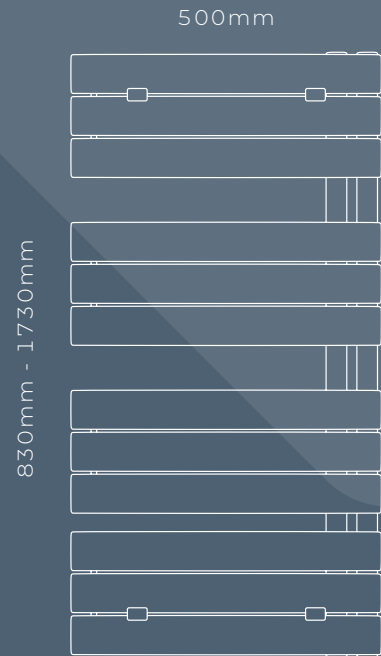

Exude luxury with high shine chrome

Only available in Chrome

5 YEAR WARRANTY

IN STOCK



Concord Side Concept

The Stelrad Concord Side Concept radiator in a matt finish Anthracite grey is a straight tubular design with piping at one side giving a sleek, stylish look to any room.

500mm

830mm - 1730mm

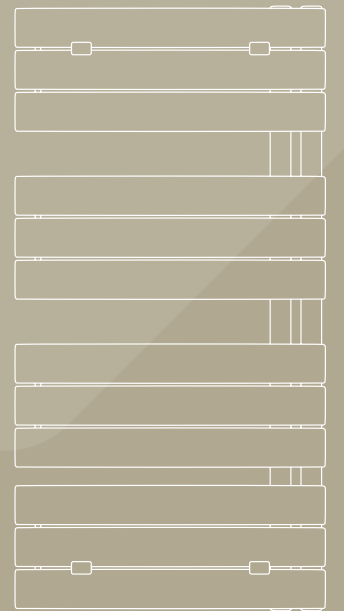

5
YEAR
WARRANTY



Only available
in Anthracite grey

Lecco

The exclusive Stelrad Home Series Lecco Towel Rail adds a designer touch of luxury to your room with its stunning combination of brushed and polished steel finishes.

Exclusive to Stelrad Group plc

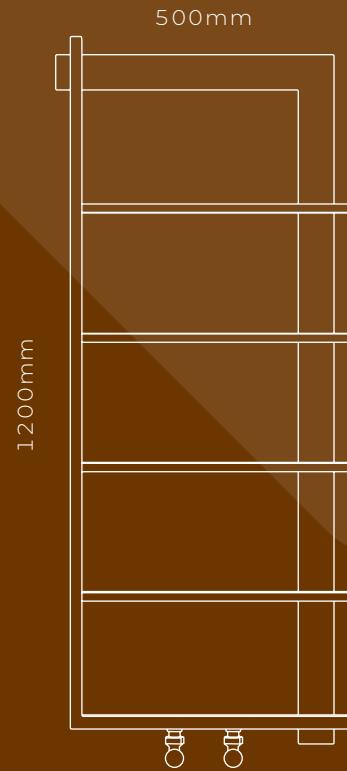

Polished finish

Brushed finish

Only available in Brushed & Polished Steel



5
YEAR
WARRANTY



IN STOCK



Ultra

The bespoke Stelrad Home Series Ultra is a modern designer radiator with optional towel rails, making it perfectly suited to bathrooms and kitchens.



Please refer to page 142 for more information on the optional towel rail bars (up to 2) and the bar sizes.

Carmine Red



Colour options available.
See pages 10 & 11.

Vertical Ultra

The Stelrad Home Series Vertical Ultra radiator is as unique as you are with the option of one or two towel rails and can be tailored to suit any bathroom or kitchen.

470mm - 670mm

1040mm - 2040mm

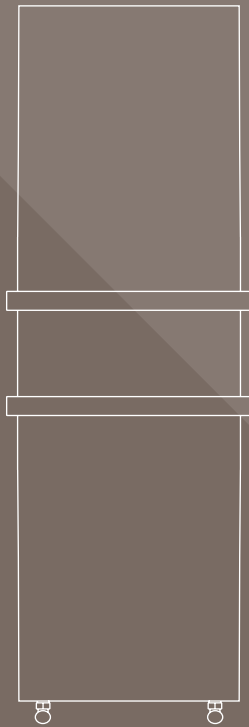

Please refer to page 142 for more information on the optional towel rail bars (up to 3) and the bar sizes.

Colour options available.
See pages 10 & 11.



Useful towel rails
make it beautiful
and practical

Mocha

SIZES, HEATING SPECIFICATIONS AND ACCESSORIES

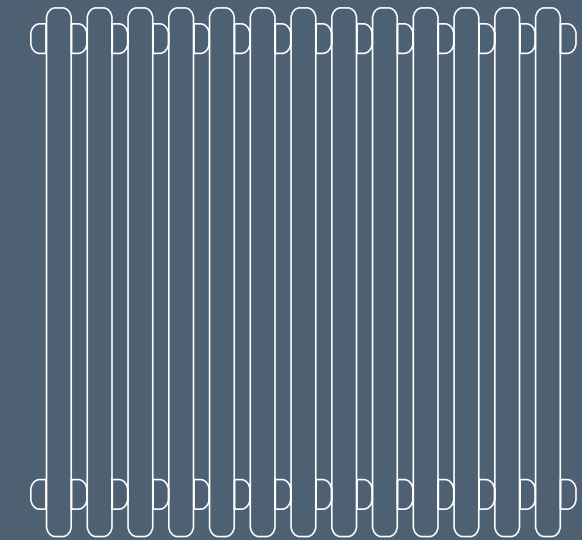
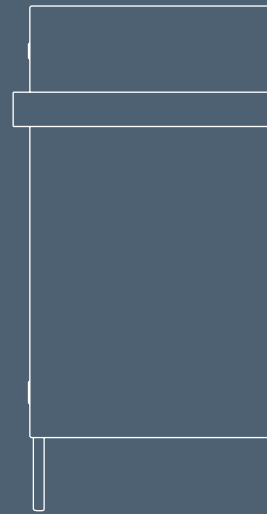
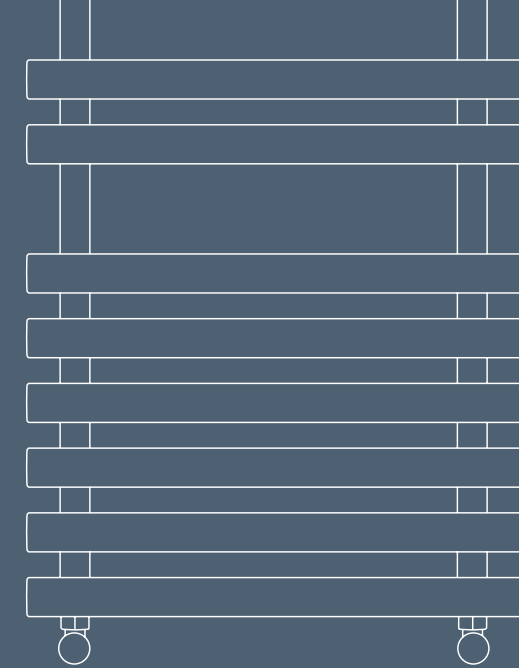
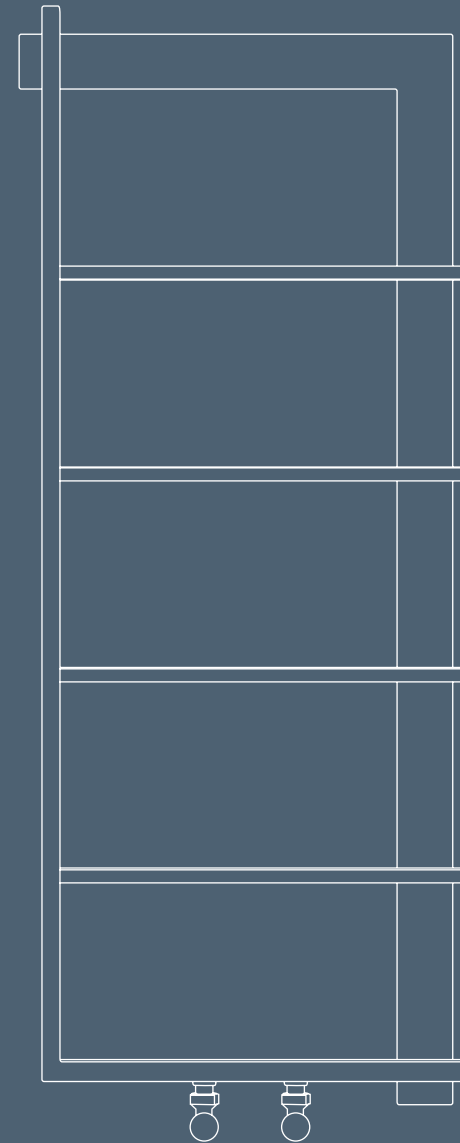
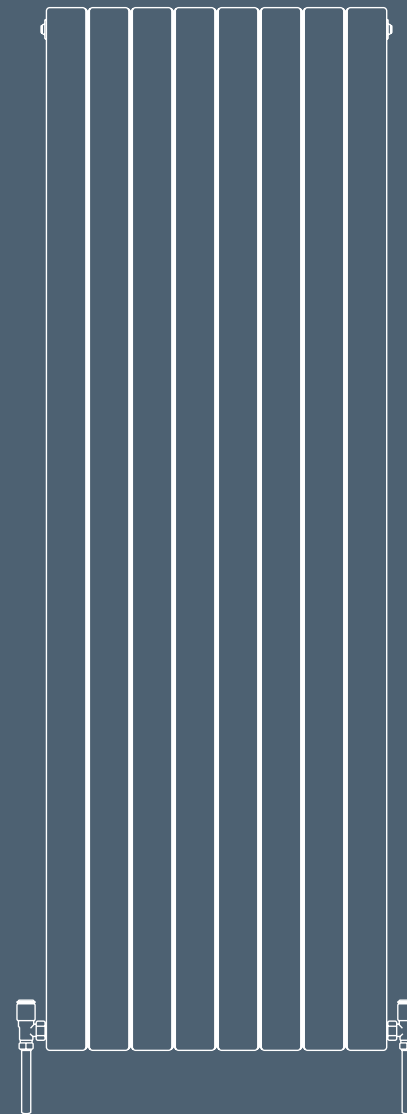
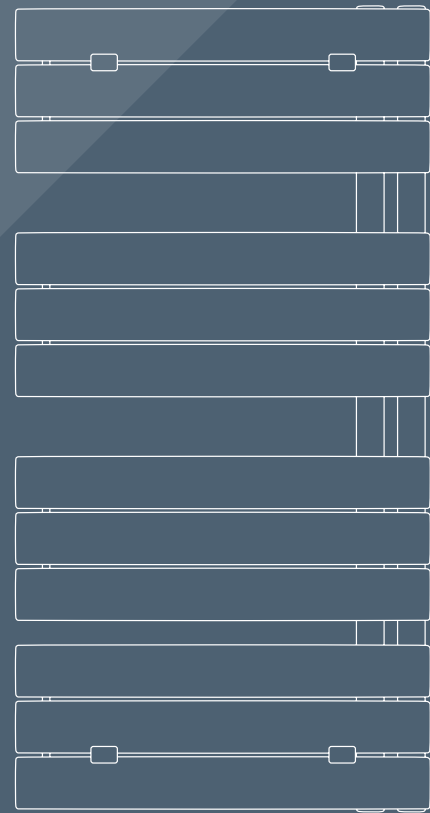
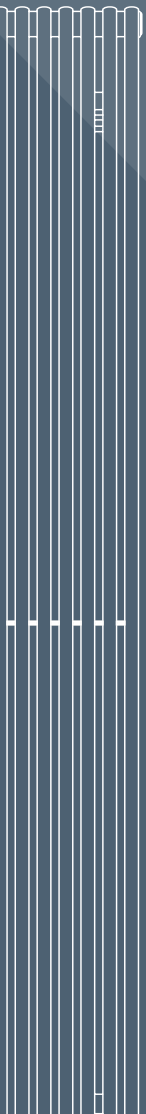

Δt_{50} is the UK's industry standard for heating outputs, which has an operating temperature of 75/65/20°C. If you have a low temperature heat source you may wish to consider Δt_{40} or Δt_{30} output (see your installer or system designer or download from www.stelrad.com).

For EN442 data, technical and installation information please visit our website: www.stelrad.com and search under advice and then downloads.

SIZES AND HEATING SPECIFICATIONS

CLASSIC COMPACT

50Δt
(75/65/20°C)



Height mm	Length mm	K1		P+		K2	
		Stelrad UIN	Heat output Watts Btu/hr	Stelrad UIN	Heat output Watts Btu/hr	Stelrad UIN	Heat output Watts Btu/hr
300	500	931105h	254 866	932105h	373 1,273	932205h	490 1,674
	1000	931110h	508 1,734	932110h	745 2,543	932210h	981 3,349
	1500	931115h	762 2,601	932115h	1,118 3,816	932215h	1,472 5,023
	2000	-	-	-	-	932220h	1,962 6,698
450	400	941104h	302 1,032	-	-	942204h	548 1,871
	500	941105h	378 1,290	942105h	528 1,801	942205h	685 2,339
	600	941106h	454 1,548	942106h	633 2,161	942206h	822 2,807
	700	941107h	529 1,806	942107h	739 2,522	942207h	959 3,274
	800	941108h	605 2,064	942108h	844 2,882	942208h	1,096 3,742
	900	941109h	680 2,322	942109h	950 3,242	942209h	1,234 4,210
	1000	941110h	756 2,579	942110h	1,055 3,602	942210h	1,371 4,678
	1100	941111h	831 2,837	942111h	1,161 3,962	942211h	1,508 5,146
	1200	941112h	907 3,095	942112h	1,267 4,323	942212h	1,645 5,613
	1400	941114h	1,058 3,611	942114h	1,478 5,044	942214h	1,919 6,549
	1600	941116h	1,209 4,127	942116h	1,689 5,764	942216h	2,193 7,485
	1800	941118h	1,360 4,643	942118h	1,900 6,485	942218h	2,467 8,420
	2000	941120h	1,512 5,159	942120h	2,111 7,205	942220h	2,742 9,358
	2200	941122h	1,603 5,470	-	-	942222h	3,016 10,294
	2400	941124h	1,814 6,190	-	-	942224h	3,290 11,230
	600	400	961104h	392 1,338	962104h	539 1,838	962204h
500		961105h	490 1,672	962105h	673 2,298	962205h	866 2,955
600		961106h	588 2,006	962106h	808 2,758	962206h	1,039 3,546
700		961107h	686 2,341	962107h	943 3,217	962207h	1,212 4,137
800		961108h	784 2,675	962108h	1,077 3,677	962208h	1,385 4,728
900		961109h	882 3,009	962109h	1,212 4,137	962209h	1,558 5,319
1000		961110h	980 3,344	962110h	1,347 4,597	962210h	1,732 5,910
1100		961111h	1,078 3,678	962111h	1,481 5,056	962211h	1,905 6,501
1200		961112h	1,176 4,013	962112h	1,616 5,516	962212h	2,078 7,092
1400		961114h	1,372 4,681	962114h	1,885 6,435	962214h	2,424 8,273
1600		961116h	1,568 5,350	962116h	2,155 7,354	962216h	2,770 9,455
1800		961118h	1,764 6,019	962118h	2,424 8,273	962218h	3,117 10,637
2000		961120h	1,946 6,642	962120h	2,694 9,193	962220h	3,466 11,831
2200		961122h	2,156 7,357	-	-	962222h	3,813 13,014
2400		961124h	2,352 8,025	-	-	962224h	4,160 14,197
700		400	971104h	447 1,524	972104h	613 2,092	972204h
	500	971105h	558 1,906	972105h	766 2,614	972205h	980 3,345
	600	971106h	670 2,287	972106h	919 3,137	972206h	1,176 4,015
	700	971107h	782 2,668	972107h	1,072 3,660	972207h	1,372 4,684
	800	971108h	893 3,049	972108h	1,226 4,183	972208h	1,568 5,353
	900	971109h	1,005 3,430	972109h	1,379 4,706	972209h	1,764 6,022
	1000	971110h	1,117 3,811	972110h	1,532 5,228	972210h	1,960 6,691
	1100	971111h	1,228 4,192	972111h	1,685 5,752	972211h	2,156 7,360
	1200	971112h	1,340 4,573	972112h	1,839 6,275	972212h	2,352 8,029
	1400	971114h	1,563 5,336	972114h	2,145 7,320	972214h	2,745 9,367
	1600	971116h	1,787 6,098	-	-	972216h	3,137 10,705
	1800	971118h	2,010 6,860	-	-	972218h	3,529 12,044
2000	971120h	2,234 7,623	-	-	972220h	3,927 13,404	

CLASSIC COMPACT XTRA PROTECTION



50Δt
(75/65/20°C)

Height mm	Length mm	K1		
		Stelrad UIN	Heat output Watts Btu/hr	
450	400	144850h	302 1,031	
	600	144851h	454 1,550	
	800	144852h	605 2,065	
	1000	144853h	756 2,580	
600	400	144854h	392 1,338	
	600	144855h	588 2,007	
	800	144856h	784 2,676	
	1000	144857h	980 3,345	
Height mm	Length mm	K2		
		Stelrad UIN	Heat output Watts Btu/hr	
450	400	144858h	548 1,870	
	600	144859h	823 2,809	
	800	144860h	1,097 3,744	
	1000	144861h	1,371 4,679	
	1200	144867h	1,645 5,614	
	1400	144868h	1,919 6,550	
	1600	144869h	2,194 7,488	
	1800	144870h	2,468 8,423	
	600	400	144862h	693 2,365
		600	144863h	1,039 3,546
800		144864h	1,386 4,730	
1000		144865h	1,732 5,911	
1200		144871h	2,078 7,092	
1400		144872h	2,425 8,277	
1600		144873h	2,771 9,457	
1800		144874h	3,118 10,642	

SIZES AND HEATING SPECIFICATIONS

CLASSIC COMPACT VERTICAL

50Δt
(75/65/20°C)

K2



Height mm	Length mm	Stelrad UIN	Heat output Watts Btu/hr	
1800	400	89121418h	1,584	5,405
	500	89122518h	1,980	6,756
	600	89122618h	2,376	8,107

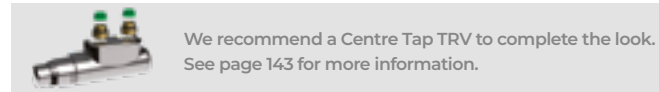

We recommend a Centre Tap TRV to complete the look. See page 143 for more information.

CLASSIC COMPACT K3 (CONTINUED)

50Δt
(75/65/20°C)

K3



Height mm	Length mm	Stelrad UIN	Heat output Watts Btu/hr	
600	400	76603304	956	3,262
	500	76603305	1,195	4,077
	600	76603306	1,433	4,889
	700	76603307	1,672	5,705
	800	76603308	1,911	6,520
	900	76603309	2,150	7,336
	1000	76603310	2,389	8,151
	1100	76603311	2,628	8,967
	1200	76603312	2,867	9,782
	1400	76603314	3,345	11,413
	1600	76603316	3,822	13,041
	1800	76603318	4,300	14,672
	2000	76603320	4,778	16,303
	2400	76603324	5,734	19,564
700	500	76703305h	1,356	4,627
	600	76703306h	1,627	5,551
	700	76703307h	1,898	6,476
	800	76703308h	2,170	7,404
	900	76703309h	2,441	8,329
	1000	76703310h	2,712	9,253
	1100	76703311h	2,983	10,178
	1200	76703312h	3,254	11,103
	1400	76703314h	3,797	12,955
	1600	76703316h	4,339	14,805
1800	76703318h	4,882	16,657	
2000	76703320h	5,424	18,507	

CLASSIC COMPACT K3

50Δt
(75/65/20°C)

K3



Height mm	Length mm	Stelrad UIN	Heat output Watts Btu/hr	
300	1000	76303310h	1,349	4,603
	2000	76303320h	2,698	9,206
500	600	76503306h	1,234	4,210
	700	76503307h	1,439	4,910
	800	76503308h	1,645	5,613
	900	76503309h	1,850	6,312
	1000	76503310h	2,056	7,015
	1100	76503311h	2,262	7,718
	1200	76503312h	2,467	8,417
	1400	76503314h	2,878	9,820
	1600	76503316h	3,290	11,225
	1800	76503318h	3,701	12,628
	2000	76503320h	4,112	14,030
	2400	76503324h	4,934	16,835

Range extension

Range extension

SIZES AND HEATING SPECIFICATIONS

VERTICAL LINE



50Δt
(75/65/20°C)

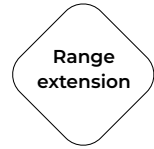

Height mm	Length mm	K1		K2			
		Stelrad UIN	Heat output Watts	Heat output Btu/h	Stelrad UIN	Heat output Watts	Heat output Btu/h
300	500	92301105h	235	802	92302205h	449	1,532
	1000	92301110h	470	1,604	92302210h	898	3,064
	1500	92301115h	705	2,405	92302215h	1,347	4,596
450	400	92451104h	272	928	92452204h	509	1,737
	600	92451106h	409	1,396	92452206h	764	2,607
	700	92451107h	477	1,628	92452207h	891	3,040
	800	92451108h	545	1,860	92452208h	1,018	3,473
	900	92451109h	613	2,092	92452209h	1,145	3,909
	1000	92451110h	681	2,324	92452210h	1,273	4,343
	1100	92451111h	749	2,556	92452211h	1,400	4,779
	1200	92451112h	817	2,788	92452212h	1,528	5,214
	1400	92451114h	953	3,252	92452214h	1,782	6,080
	1600	92451116h	1,090	3,719	92452216h	2,037	6,950
600	1800	92451118h	1,226	4,183	92452218h	2,291	7,817
	400	92601104h	348	1,187	92602204h	640	2,184
	600	92601106h	522	1,781	92602206h	961	3,279
	700	92601107h	609	2,078	92602207h	1,121	3,825
	800	92601108h	696	2,375	92602208h	1,281	4,371
	900	92601109h	783	2,672	92602209h	1,441	4,917
	1000	92601110h	870	2,968	92602210h	1,601	5,463
	1100	92601111h	957	3,265	92602211h	1,761	6,009
	1200	92601112h	957	3,265	92602212h	1,921	6,554
	1400	92601114h	1,218	4,156	92602214h	2,241	7,646
1600	92601116h	1,392	4,750	92602216h	2,562	8,742	
1800	92601118h	1,566	5,343	92602218h	2,882	9,833	
2000	92601120h	1,740	5,937	92602220h	3,202	10,925	

VERTICAL LINE VERTICAL



50Δt
(75/65/20°C)

Height mm	Length mm	K2		
		Stelrad UIN	Heat output Watts	Heat output Btu/hr
1800	400	89222418h	1,476	5,036
	500	89222518h	1,845	6,295
	600	89222618h	2,214	7,554

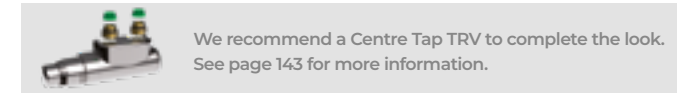

We recommend a Centre Tap TRV to complete the look. See page 143 for more information.

VERTICAL LINE CONCEPT



50Δt
(75/65/20°C)

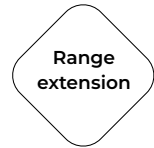

Height mm	Length mm	K1		K2			
		Stelrad UIN	Heat output Watts	Heat output Btu/h	Stelrad UIN	Heat output Watts	Heat output Btu/h
600	400	51601104h	348	1,187	51602204h	640	2,184
	600	51601106h	522	1,781	51602206h	961	3,279
	700	51601107h	609	2,078	51602207h	1,121	3,825
	800	51601108h	696	2,375	51602208h	1,281	4,371
	900	51601109h	783	2,672	51602209h	1,441	4,917
	1000	51601110h	870	2,968	51602210h	1,601	5,463
	1100	51601111h	957	3,265	51602211h	1,761	6,009
1200	51601112h	1,044	3,562	51602212h	1,921	6,554	
1400	51601114h	1,218	4,156	51602214h	2,241	7,646	

VERTICAL LINE VERTICAL CONCEPT

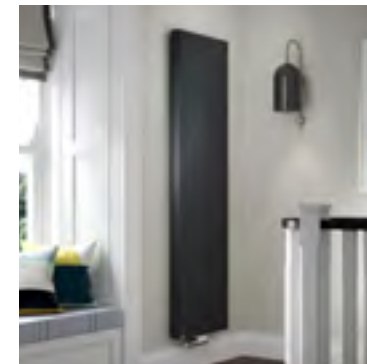

50Δt
(75/65/20°C)

Height mm	Length mm	K2		
		Stelrad UIN	Heat output Watts	Heat output Btu/hr
1800	400	22182204h	1,476	5,036
	500	22182205h	1,845	6,295
	600	22182206h	2,214	7,554

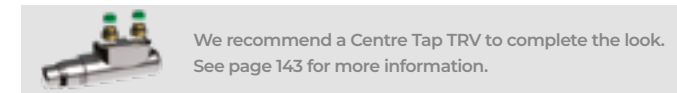

We recommend a Centre Tap TRV to complete the look. See page 143 for more information.

SIZES AND HEATING SPECIFICATIONS

HORIZONTAL LINE

50Δt
(75/65/20°C)

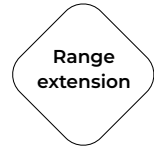

Height mm	Length mm	K1		K2			
		Stelrad UIN	Heat output Watts	Btu/h	Stelrad UIN	Heat output Watts	Btu/h
300	500	82301105h	235	802	82302205h	449	1,532
	1000	82301110h	469	1,601	82302210h	898	3,064
	1500	82301115h	704	2,401	82302215h	1,347	4,596
450	400	82451104h	272	928	82452204h	509	1,737
	600	82451106h	409	1,396	82452206h	764	2,607
	700	82451107h	477	1,628	82452207h	891	3,040
	800	82451108h	545	1,860	82452208h	1,018	3,474
	900	82451109h	613	2,092	82452209h	1,145	3,909
	1000	82451110h	681	2,324	82452210h	1,273	4,344
	1100	82451111h	749	2,556	82452211h	1,400	4,779
	1200	82451112h	817	2,788	82452212h	1,528	5,214
	1400	82451114h	953	3,252	82452214h	1,782	6,080
	1600	82451116h	1,090	3,719	82452216h	2,037	6,951
	1800	82451118h	1,226	4,183	82452218h	2,291	7,817
600	400	82601104h	348	1,188	82602204h	640	2,184
	600	82601106h	522	1,782	82602206h	961	3,280
	700	82601107h	609	2,078	82602207h	1,121	3,825
	800	82601108h	696	2,375	82602208h	1,281	4,372
	900	82601109h	783	2,672	82602209h	1,441	4,917
	1000	82601110h	870	2,969	82602210h	1,601	5,464
	1100	82601111h	957	3,265	82602211h	1,761	6,009
	1200	82601112h	1,044	3,563	82602212h	1,921	6,556
	1400	82601114h	1,218	4,157	82602214h	2,242	7,649
	1600	82601116h	1,392	4,751	82602216h	2,563	8,744
	1800	82601118h	1,566	5,345	82602218h	2,883	9,836
2000	82601120h	1,740	5,939	82602220h	3,203	10,928	

LST STANDARD HORIZONTAL LINE

50Δt
(75/65/20°C)



Height mm	Length mm	K1		P+		K2					
		Stelrad UIN	Heat output Watts	Btu/hr	Stelrad UIN	Heat output Watts	Btu/hr	Stelrad UIN	Heat output Watts	Btu/hr	
500	560	245000h	196	669	245008h	284	969	245016h	348	1,187	
	760	245001h	293	1,000	245009h	426	1,454	245017h	522	1,781	
	960	245002h	391	1,334	245010h	568	1,938	245018h	696	2,375	
	1160	245003h	489	1,668	245011h	710	2,423	245019h	870	2,968	
	1360	245004h	587	2,003	245012h	852	2,907	245020h	1,044	3,562	
	1560	245005h	685	2,337	245013h	994	3,392	245021h	1,218	4,156	
	1760	245006h	782	2,668	245014h	1,136	3,876	245022h	1,392	4,750	
	1960	245007h	880	3,003	245015h	1,278	4,361	245023h	1,566	5,343	
	650	560	245024h	290	989	245032h	386	1,317	245040h	478	1,631
		760	245025h	435	1,484	245033h	580	1,979	245041h	717	2,446
960		245026h	580	1,979	245034h	773	2,637	245042h	956	3,262	
1160		245027h	725	2,474	245035h	966	3,296	245043h	1,195	4,077	
1360		245028h	870	2,968	245036h	1,159	3,955	245044h	1,434	4,893	
1560		245029h	1,015	3,463	245037h	1,352	4,613	245045h	1,673	5,708	
1760		245030h	1,160	3,958	245038h	1,546	5,275	245046h	1,912	6,524	
1960		245031h	1,305	4,453	245039h	1,739	5,933	245047h	2,151	7,339	
800		460	245072h	274	935	-	-	-	245073h	461	1,573
		560	245048h	365	1,245	245056h	501	1,709	245064h	615	2,098
	760	245049h	548	1,870	245057h	751	2,562	245065h	922	3,146	
	960	245050h	730	2,491	245058h	1,002	3,419	245066h	1,230	4,197	
	1160	245051h	913	3,115	245059h	1,252	4,272	245067h	1,537	5,244	
	1360	245052h	1,096	3,740	245060h	1,502	5,125	245068h	1,844	6,292	
	1560	245053h	1,278	4,361	245061h	1,753	5,981	245069h	2,152	7,343	
	1760	245054h	1,461	4,985	245062h	2,003	6,834	245070h	2,459	8,390	
1960	245055h	1,643	5,606	245063h	2,254	7,691	245071h	2,767	9,441		

HORIZONTAL LINE CONCEPT

50Δt
(75/65/20°C)

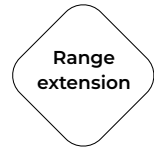

Height mm	Length mm	K1		K2			
		Stelrad UIN	Heat output Watts	Btu/h	Stelrad UIN	Heat output Watts	Btu/h
600	400	22601104h	348	1,187	22602204h	640	2,184
	600	22601106h	522	1,781	22602206h	961	3,279
	700	22601107h	609	2,078	22602207h	1,121	3,825
	800	22601108h	696	2,375	22602208h	1,281	4,371
	900	22601109h	783	2,672	22602209h	1,441	4,917
	1000	22601110h	870	2,968	22602210h	1,601	5,463
	1100	22601111h	957	3,265	22602211h	1,761	6,009
	1400	22601114h	1,218	4,156	22602214h	2,241	7,646

SIZES AND HEATING SPECIFICATIONS

LST i PLUS HORIZONTAL LINE



50Δt
(75/65/20°C)

Height mm	Length mm	K1			P+			K2		
		Stelrad UIN	Heat output Watts	Heat output Btu/hr	Stelrad UIN	Heat output Watts	Heat output Btu/hr	Stelrad UIN	Heat output Watts	Heat output Btu/hr
500	650	245200h	196	669	245248h	284	969	245224h	348	1,187
	850	245201h	293	1,000	245249h	426	1,454	245225h	522	1,781
	1050	245202h	391	1,334	245250h	568	1,938	245226h	696	2,375
	1250	245203h	489	1,668	245251h	710	2,423	245227h	870	2,968
	1450	245204h	587	2,003	245252h	852	2,907	245228h	1,044	3,562
	1650	245205h	685	2,337	245253h	994	3,392	245229h	1,218	4,156
	1850	245206h	782	2,668	245254h	1,136	3,876	245230h	1,392	4,750
	2050	245207h	880	3,003	245255h	1,278	4,361	245231h	1,566	5,343
	650	650	245208h	290	989	245256h	386	1,317	245232h	478
850		245209h	435	1,484	245257h	580	1,979	245233h	717	2,446
1050		245210h	580	1,979	245258h	773	2,637	245234h	956	3,262
1250		245211h	725	2,474	245259h	966	3,296	245235h	1,195	4,077
1450		245212h	870	2,968	245260h	1,159	3,955	245236h	1,434	4,893
1650		245213h	1,015	3,463	245261h	1,352	4,613	245237h	1,673	5,708
1850		245214h	1,160	3,958	245262h	1,546	5,275	245238h	1,912	6,524
2050		245215h	1,305	4,453	245263h	1,739	5,933	245239h	2,151	7,339
800		650	245216h	365	1,245	245264h	501	1,709	245240h	615
	850	245217h	548	1,870	245265h	751	2,562	245241h	922	3,146
	1050	245218h	730	2,491	245266h	1,002	3,419	245242h	1,230	4,197
	1250	245219h	913	3,115	245267h	1,252	4,272	245243h	1,537	5,244
	1450	245220h	1,096	3,740	245268h	1,502	5,125	245244h	1,844	6,292
	1650	245221h	1,278	4,361	245269h	1,753	5,981	245245h	2,152	7,343
	1850	245222h	1,461	4,985	245270h	2,003	6,834	245246h	2,459	8,390
	2050	245223h	1,643	5,606	245271h	2,254	7,691	245247h	2,767	9,441

FLAT

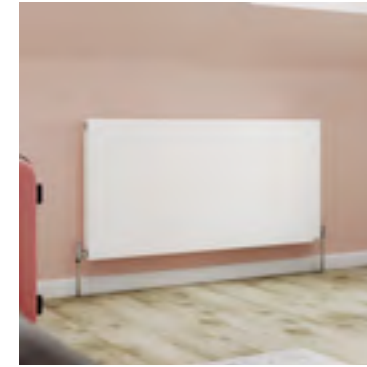

50Δt
(75/65/20°C)

Height mm	Length mm	K1			K2		
		Stelrad UIN	Heat output Watts	Heat output Btu/h	Stelrad UIN	Heat output Watts	Heat output Btu/h
300	500	81301105h	235	802	81302205h	465	1,587
	1000	81301110h	469	1,601	81302210h	929	3,171
	1500	81301115h	704	2,401	81302215h	1,394	4,756
450	400	81451104h	280	955	81452204h	518	1,767
	600	81451106h	421	1,437	81452206h	778	2,655
	800	81451108h	561	1,914	81452208h	1,037	3,538
	1000	81451110h	701	2,392	81452210h	1,296	4,422
	1200	81451112h	841	2,870	81452212h	1,555	5,306
	1400	81451114h	981	3,347	81452214h	1,814	6,190
	1600	81451116h	1,122	3,828	81452216h	2,074	7,077
	1800	81451118h	1,262	4,306	81452218h	2,333	7,961
600	400	81601104h	364	1,242	81602204h	654	2,231
	600	81601106h	547	1,866	81602206h	980	3,344
	800	81601108h	729	2,487	81602208h	1,307	4,459
	1000	81601110h	911	3,108	81602210h	1,634	5,575
	1200	81601112h	1,093	3,729	81602212h	1,961	6,691
	1400	81601114h	1,275	4,350	81602214h	2,288	7,807
	1600	81601116h	1,458	4,975	81602216h	2,614	8,919
	1800	81601118h	1,640	5,596	81602218h	2,941	10,035
	2000	81601120h	1,822	6,217	81602220h	3,268	11,150

FLAT CONCEPT

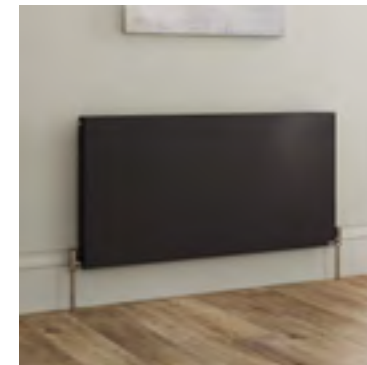

50Δt
(75/65/20°C)

Height mm	Length mm	K1			K2		
		Stelrad UIN	Heat output Watts	Heat output Btu/h	Stelrad UIN	Heat output Watts	Heat output Btu/h
600	400	21601104h	364	1,242	21602204h	654	2,231
	600	21601106h	547	1,866	21602206h	980	3,344
	800	21601108h	729	2,487	21602208h	1,307	4,459
	1000	21601110h	911	3,108	21602210h	1,634	5,575
	1200	21601112h	1,093	3,729	21602212h	1,961	6,691
	1400	21601114h	1,275	4,350	21602214h	2,288	7,807

SIZES AND HEATING SPECIFICATIONS

FLAT VERTICAL

50Δt

(75/65/20°C)

K2



Height mm	Length mm	Stelrad UIN	Heat output	
			Watts	Btu/hr
1800	400	89322418h	1,476	5,036
	500	89322518h	1,845	6,295
	600	89322618h	2,214	7,554

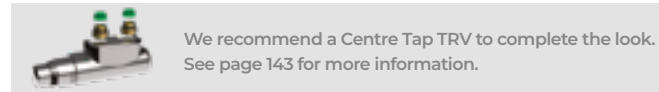

CONCORD LO-LINE COLOURED

50Δt

(75/65/20°C)

DOUBLE



Height mm	Length mm	Stelrad UIN	Heat output	
			Watts	Btu/hr
148	800	148456h	541	1,846
	1000	148457h	676	2,307
	1200	148458h	811	2,767
	1400	148459h	946	3,228
	1600	148460h	1,082	3,692
	1800	148461h	1,217	4,153
	2000	148462h	1,352	4,613
	2200	148463h	1,487	5,074
296	800	148464h	892	3,044
	1000	148465h	1,115	3,805
	1200	148466h	1,338	4,565
	1400	148467h	1,561	5,326
	1600	148468h	1,784	6,087
	1800	148469h	2,007	6,848
	2000	148470h	2,230	7,609
	2200	148471h	2,453	8,370

FLAT VERTICAL CONCEPT

50Δt

(75/65/20°C)

K2



Height mm	Length mm	Stelrad UIN	Heat output	
			Watts	Btu/hr
1800	400	21182204h	1,476	5,036
	500	21182205h	1,845	6,295
	600	21182206h	2,214	7,554

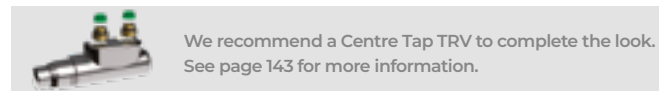

CONCORD PLANE

50Δt

(75/65/20°C)

SINGLE

DOUBLE



Height mm	Length mm	Stelrad UIN	Heat output		Stelrad UIN	Heat output	
			Watts	Btu/hr		Watts	Btu/hr
444	500	448346h	392	1,338	448397h	685	2,337
	600	448347h	470	1,604	448398h	821	2,801
	700	448348h	549	1,873	448399h	958	3,269
	800	448349h	627	2,139	448400h	1,095	3,736
	900	448350h	706	2,409	448401h	1,232	4,204
	1000	448351h	784	2,675	448402h	1,369	4,671
	1100	448352h	862	2,941	448403h	1,506	5,139
	1200	448353h	941	3,211	448404h	1,643	5,606
	1400	448354h	1,098	3,747	448405h	1,917	6,541
	592	500	448363h	501	1,709	448414h	849
600		448364h	601	2,051	448415h	1,018	3,474
700		448365h	701	2,392	448416h	1,188	4,054
800		448366h	802	2,737	448417h	1,358	4,634
900		448367h	902	3,078	448418h	1,527	5,210
1000		448368h	1,002	3,419	448419h	1,697	5,790
1100		448369h	1,102	3,760	448420h	1,867	6,370
1200		448370h	1,202	4,101	448421h	2,036	6,947
1400	448371h	1,403	4,787	448422h	2,376	8,107	

SIZES AND HEATING SPECIFICATIONS

CONCORD PLANE COLOURED



50Δt
(75/65/20°C)

Height mm	Length mm	SINGLE			DOUBLE		
		Stelrad UIN	Heat output Watts	Heat output Btu/h	Stelrad UIN	Heat output Watts	Heat output Btu/h
444	500	148478h	392	1,338	148529h	685	2,337
	600	148479h	470	1,604	148530h	821	2,801
	700	148480h	549	1,873	148531h	958	3,269
	800	148481h	627	2,139	148532h	1,095	3,736
	900	148482h	706	2,409	148533h	1,232	4,204
	1000	148483h	784	2,675	148534h	1,369	4,671
	1100	148484h	862	2,941	148535h	1,506	5,139
	1200	148485h	941	3,211	148536h	1,643	5,606
	1400	148486h	1,098	3,747	148537h	1,917	6,541
	1600	148487h	1,254	4,279	148538h	2,190	7,473
	1800	148488h	1,411	4,815	148539h	2,464	8,408
	2000	148489h	1,568	5,350	148540h	2,738	9,342
	2200	148490h	1,725	5,886	148541h	3,012	10,277
	2400	148491h	1,882	6,422	148542h	3,286	11,212
	2600	148492h	2,038	6,954	148543h	3,559	12,144
	2800	148493h	2,195	7,490	148544h	3,833	13,079
	3000	148494h	2,352	8,025	148545h	4,107	14,014
	592	500	148495h	501	1,709	148546h	849
600		148496h	601	2,051	148547h	1,018	3,474
700		148497h	701	2,392	148548h	1,188	4,054
800		148498h	802	2,737	148549h	1,358	4,634
900		148499h	902	3,078	148550h	1,527	5,210
1000		148500h	1,002	3,419	148551h	1,697	5,790
1100		148501h	1,102	3,760	148552h	1,867	6,370
1200		148502h	1,202	4,101	148553h	2,036	6,947
1400		148503h	1,403	4,787	148554h	2,376	8,107
1600		148504h	1,603	5,470	148555h	2,715	9,264
1800		148505h	1,804	6,156	148556h	3,055	10,424
2000		148506h	2,004	6,838	148557h	3,394	11,581
2200		148507h	2,204	7,520	148558h	3,733	12,738
2400		148508h	2,405	8,206	148559h	4,073	13,898
2600		148509h	2,605	8,889	148560h	4,412	15,054
2800		148510h	2,806	9,574	148561h	4,752	16,214
3000		148511h	3,006	10,257	148562h	5,091	17,371
740		500	148512h	598	2,040	148563h	1,001
	600	148513h	718	2,450	148564h	1,201	4,098
	700	148514h	837	2,856	148565h	1,401	4,780
	800	148515h	957	3,265	148566h	1,602	5,466
	900	148516h	1,076	3,671	148567h	1,802	6,149
	1000	148517h	1,196	4,081	148568h	2,002	6,831
	1100	148518h	1,316	4,490	148569h	2,202	7,514
	1200	148519h	1,435	4,896	148570h	2,402	8,196
	1400	148520h	1,674	5,712	148571h	2,803	9,564
	1600	148521h	1,914	6,531	148572h	3,203	10,929
	1800	148522h	2,153	7,346	148573h	3,604	12,297
	2000	148523h	2,392	8,162	148574h	4,004	13,662
	2200	148524h	2,631	8,977	148575h	4,404	15,027
	2400	148525h	2,870	9,793	148576h	4,805	16,395
	2600	148526h	3,110	10,612	148577h	5,205	17,760
	2800	148527h	3,349	11,427	148578h	5,606	19,128
	3000	148528h	3,588	12,243	148579h	6,006	20,493

CONCORD VERTICAL 50Δt (75/65/20°C)



Height mm	Length mm	SINGLE			DOUBLE		
		Stelrad UIN	Heat output Watts	Heat output Btu/h	Stelrad UIN	Heat output Watts	Heat output Btu/h
1800	444	448340h	852	2,907	448640h	1,254	4,279
	592	448341h	1,136	3,876	448641h	1,672	5,705
	740	448342h	1,420	4,845	448642h	2,090	7,131
2000	444	448343h	942	3,214	448643h	1,386	4,729
	592	448344h	1,256	4,286	448644h	1,848	6,306
	740	448345h	1,570	5,357	448645h	2,310	7,882

CONCORD VERTICAL CONCEPT 50Δt (75/65/20°C)



Height mm	Length mm	SINGLE			DOUBLE		
		Stelrad UIN	Heat output Watts	Heat output Btu/h	Stelrad UIN	Heat output Watts	Heat output Btu/h
1800	444	448652h	852	2,907	448655h	1,254	4,279
	592	448653h	1,136	3,876	448656h	1,672	5,705
	740	448654h	1,420	4,845	448657h	2,090	7,131

SIZES AND HEATING SPECIFICATIONS

CONCORD VERTICAL COLOURED

50Δt
(75/65/20°C)



Height mm	Length mm	SINGLE		DOUBLE			
		Stelrad UIN	Heat output Watts	Heat output Btu/h	Stelrad UIN	Heat output Watts	Heat output Btu/h
1800	444	148472h	852	2,907	148646h	1,254	4,279
	592	148473h	1,136	3,876	148647h	1,672	5,705
	740	148474h	1,420	4,845	148648h	2,090	7,131
2000	444	148475h	942	3,214	148649h	1,386	4,729
	592	148476h	1,256	4,286	148650h	1,848	6,306
	740	148477h	1,570	5,357	148651h	2,310	7,882

CONCORD SLIMLINE

50Δt
(75/65/20°C)



Height mm	Length mm	SINGLE		
		Stelrad UIN	Heat output Watts	Heat output Btu/h
1800	320	448300h	872	2,975
	440	448301h	1,199	4,091
	520	448302h	1,417	4,835
	640	448303h	1,744	5,951
2000	320	448304h	978	3,337
	440	448305h	1,344	4,586
	520	448306h	1,589	5,422
	640	448307h	1,956	6,674

CONCORD CHROME VERTICAL

50Δt
(75/65/20°C)



Height mm	Length mm	SINGLE		
		Stelrad UIN	Heat output Watts	Heat output Btu/h
1800	310	751101h	395	1,348
	390	751102h	495	1,688
	470	751103h	528	1,801
	604	751104h	654	2,232

CONCORD SLIMLINE CONCEPT

50Δt
(75/65/20°C)



Height mm	Length mm	SINGLE		
		Stelrad UIN	Heat output Watts	Heat output Btu/h
1800	320	448658h	872	2,975
	440	448659h	1,199	4,091
	520	448660h	1,417	4,835
	640	448661h	1,744	5,951

SIZES AND HEATING SPECIFICATIONS

CONCORD SLIMLINE COLOURED

50Δt
(75/65/20°C)



	Height mm	Length mm	SINGLE		
			Stelrad UIN	Heat output Watts	Heat output Btu/h
1800		320	148448h	872	2,975
		440	148449h	1,199	4,091
		520	148450h	1,417	4,835
		640	148451h	1,744	5,951
2000		320	148452h	978	3,337
		440	148453h	1,344	4,586
		520	148454h	1,589	5,422
		640	148455h	1,956	6,674

COLUMN CONCEPT

50Δt
(75/65/20°C)

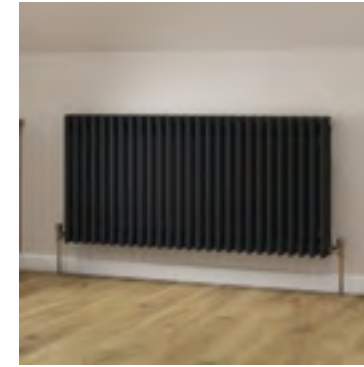

	Height mm	Length mm	3 COLUMN			4 COLUMN		
			Stelrad UIN	Heat output Watts	Heat output Btu/h	Stelrad UIN	Heat output Watts	Heat output Btu/h
600		628	463133h	792	2,703	463140h	1,037	3,539
		858	463134h	1,096	3,741	463141h	1,436	4,901
		1042	463135h	1,340	4,573	463142h	1,756	5,993
		1272	463136h	1,644	5,611	463143h	2,155	7,355

COLUMN HORIZONTAL

50Δt
(75/65/20°C)



	Height mm	Length mm	2 COLUMN			3 COLUMN			4 COLUMN		
			Stelrad UIN	Heat output Watts	Heat output Btu/hr	Stelrad UIN	Heat output Watts	Heat output Btu/hr	Stelrad UIN	Heat output Watts	Heat output Btu/hr
300		444	-	-	-	463000h	288	983	463007h	377	1,287
		628	-	-	-	463001h	416	1,420	463008h	545	1,860
		858	-	-	-	463002h	576	1,966	463009h	754	2,573
		1042	-	-	-	463003h	704	2,403	463010h	922	3,147
		1272	-	-	-	463004h	864	2,949	463011h	1,131	3,860
		1456	-	-	-	463005h	992	3,386	-	-	-
		1870	-	-	-	463006h	1,280	4,369	-	-	-
500		444	-	-	-	463016h	464	1,584	463023h	608	2,075
		628	463012h	499	1,703	463017h	671	2,290	463024h	879	3,000
		858	463013h	691	2,358	463018h	929	3,171	463025h	1,217	4,154
		1042	463014h	845	2,884	463019h	1,135	3,874	463026h	1,487	5,075
		1272	463015h	1,037	3,539	463020h	1,393	4,754	463027h	1,825	6,229
		1456	-	-	-	463021h	1,600	5,461	-	-	-
		1870	-	-	-	463022h	2,064	7,044	-	-	-
600		444	-	-	-	463032h	548	1,870	463039h	718	2,451
		628	463028h	589	2,010	463033h	792	2,703	463040h	1,037	3,539
		858	463029h	815	2,782	463034h	1,096	3,741	463041h	1,436	4,901
		1042	463030h	997	3,403	463035h	1,340	4,573	463042h	1,756	5,993
		1272	463031h	1,223	4,174	463036h	1,644	5,611	463043h	2,155	7,355
		1456	-	-	-	463037h	1,888	6,444	-	-	-
		1870	-	-	-	463038h	2,436	8,314	-	-	-
750		444	-	-	-	-	-	-	463049h	877	2,993
		628	-	-	-	-	-	-	463050h	1,266	4,321
		858	-	-	-	463044h	1,337	4,563	463051h	1,753	5,983
		1042	-	-	-	463045h	1,635	5,580	463052h	2,143	7,314
		1272	-	-	-	463046h	2,006	6,846	463053h	2,630	8,976
		1456	-	-	-	463047h	2,303	7,860	-	-	-
		1870	-	-	-	463048h	2,972	10,143	-	-	-

COLUMN HORIZONTAL COLOURED

50Δt
(75/65/20°C)

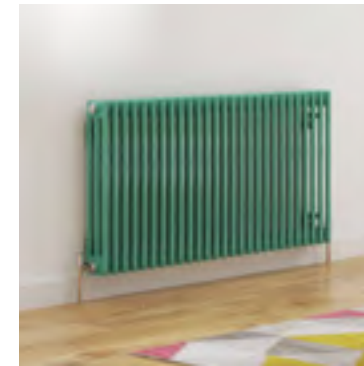

	Height mm	Length mm	2 COLUMN			3 COLUMN			4 COLUMN		
			Stelrad UIN	Heat output Watts	Heat output Btu/hr	Stelrad UIN	Heat output Watts	Heat output Btu/hr	Stelrad UIN	Heat output Watts	Heat output Btu/hr
300		444	-	-	-	163000h	288	983	163007h	377	1,287
		628	-	-	-	163001h	416	1,420	163008h	545	1,860
		858	-	-	-	163002h	576	1,966	163009h	754	2,573
		1042	-	-	-	163003h	704	2,403	163010h	922	3,147
		1272	-	-	-	163004h	864	2,949	163011h	1,131	3,860
		1456	-	-	-	163005h	992	3,386	-	-	-
		1870	-	-	-	163006h	1,280	4,369	-	-	-
500		444	163012h	499	1,703	163016h	464	1,584	163023h	608	2,075
		628	163013h	691	2,358	163017h	671	2,290	163024h	879	3,000
		858	163014h	845	2,884	163018h	929	3,171	163025h	1,217	4,154
		1042	163015h	1,037	3,539	163019h	1,135	3,874	163026h	1,487	5,075
		1272	-	-	-	163020h	1,393	4,754	163027h	1,825	6,229
		1456	-	-	-	163021h	1,600	5,461	-	-	-
		1870	-	-	-	163022h	2,064	7,044	-	-	-
600		444	-	-	-	163032h	548	1,870	163039h	718	2,451
		628	163028h	589	2,010	163033h	792	2,703	163040h	1,037	3,539
		858	163029h	815	2,782	163034h	1,096	3,741	163041h	1,436	4,901
		1042	163030h	997	3,403	163035h	1,340	4,573	163042h	1,756	5,993
		1272	163031h	1,223	4,174	163036h	1,644	5,611	163043h	2,155	7,355
		1456	-	-	-	163037h	1,888	6,444	-	-	-
		1870	-	-	-	163038h	2,436	8,314	-	-	-
750		444	-	-	-	-	-	-	163049h	877	2,993
		628	-	-	-	-	-	-	163050h	1,266	4,321
		858	-	-	-	163044h	1,337	4,563	163051h	1,753	5,983
		1042	-	-	-	163045h	1,635	5,580	163052h	2,143	7,314
		1272	-	-	-	163046h	2,006	6,846	163053h	2,630	8,976
		1456	-	-	-	163047h	2,303	7,860	-	-	-
		1870	-	-	-	163048h	2,972	10,143	-	-	-

SIZES AND HEATING SPECIFICATIONS

COLUMN VERTICAL

50Δt

(75/65/20°C)

2 COLUMN



Height mm	Length mm	Stelrad UIN	Watts	Heat output Btu/hr
1800	352	463054h	868	2,962
	444	463055h	1,116	3,809
2000	352	463056h	966	3,297
	444	463057h	1,242	4,239
2500	352	463058h	1,197	4,085
	444	463059h	1,539	5,253

COLUMN VERTICAL COLOURED

50Δt

(75/65/20°C)

2 COLUMN

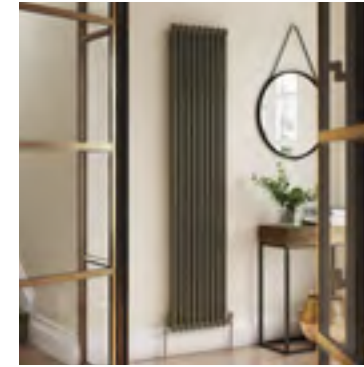

Height mm	Length mm	Stelrad UIN	Watts	Heat output Btu/hr
1800	352	163054h	868	2,962
	444	163055h	1,116	3,809
2000	352	163056h	966	3,297
	444	163057h	1,242	4,239
2500	352	163058h	1,197	4,085
	444	163059h	1,539	5,253

COLUMN VERTICAL CONCEPT

50Δt

(75/65/20°C)

2 COLUMN



Height mm	Length mm	Stelrad UIN	Watts	Heat output Btu/hr
1800	444	463155h	1,116	3,809
2000	444	463157h	1,242	4,239

CAST IRON COLUMN

50Δt

(75/65/20°C)

Range extension



4 COLUMN

Height mm	Length mm	Stelrad UIN	Watts	Heat output Btu/hr	Weight (kg)
360	512	264073h	344	1,174	28
	573	264074h	387	1,320	31
	634	264075h	430	1,467	34
	695	264076h	473	1,614	38
	756	264077h	516	1,761	41
	816	264078h	559	1,907	45
	877	264079h	602	2,054	48
	938	264080h	645	2,201	52
	999	264081h	688	2,347	55
	1,060	264082h	731	2,494	59
	1,120	264083h	774	2,641	62
1,181	264084h	817	2,788	65	

For important information regarding weight and delivery please visit www.stelrad.com

SIZES AND HEATING SPECIFICATIONS

CAST IRON COLUMN (CONTINUED)



50Δt
(75/65/20°C)

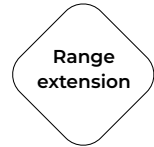

4 COLUMN

Height mm	Length mm	Stelrad UIN	Heat output		Weight (kg)
			Watts	Btu/hr	
505	512	264085h	520	1,774	34
	573	264086h	585	1,996	38
	634	264087h	650	2,218	42
	695	264088h	715	2,440	46
	756	264089h	780	2,661	50
	816	264090h	845	2,883	55
	877	264091h	910	3,105	59
	938	264092h	975	3,327	63
	999	264093h	1,040	3,548	67
	1,060	264094h	1,105	3,770	71
	1,120	264095h	1,170	3,992	75
1,181	264096h	1,235	4,214	80	
660	512	264001h	744	2,539	44
	573	264002h	837	2,856	50
	634	264003h	930	3,173	56
	695	264004h	1,023	3,490	61
	756	264005h	1,116	3,808	67
	816	264006h	1,209	4,125	72
	877	264007h	1,302	4,442	78
	938	264008h	1,395	4,760	83
	999	264009h	1,488	5,077	89
	1,060	264010h	1,581	5,394	94
	1,120	264011h	1,674	5,712	100
1,181	264012h	1,767	6,029	106	
760	512	264013h	864	2,948	50
	573	264014h	972	3,316	56
	634	264015h	1,080	3,685	62
	695	264016h	1,188	4,053	68
	756	264017h	1,296	4,422	75
	816	264018h	1,404	4,790	81
	877	264019h	1,512	5,159	87
	938	264020h	1,620	5,527	93
	999	264021h	1,728	5,896	100
	1,060	264022h	1,836	6,264	106
	1,120	264023h	1,944	6,633	112
1,181	264024h	2,052	7,001	118	
960	512	264025h	1,112	3,794	63
	573	264026h	1,251	4,268	71
	634	264027h	1,390	4,743	79
	695	264028h	1,529	5,217	86
	756	264029h	1,668	5,691	94
	816	264030h	1,807	6,165	102
	877	264031h	1,946	6,640	110
	938	264032h	2,085	7,114	118
	999	264033h	2,224	7,588	126
	1,060	264034h	2,363	8,063	133
	1,120	264035h	2,502	8,537	141
1,181	264036h	2,641	9,011	149	

CAST IRON COLUMN (CONTINUED)



50Δt
(75/65/20°C)

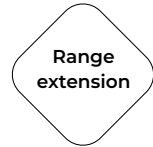

6 COLUMN

Height mm	Length mm	Stelrad UIN	Heat output		Weight (kg)
			Watts	Btu/hr	
505	512	264037h	760	2,593	67
	573	264038h	855	2,917	75
	634	264039h	950	3,241	84
	695	264040h	1,045	3,566	92
	756	264041h	1,140	3,890	100
	816	264042h	1,235	4,214	109
	877	264043h	1,330	4,538	117
	938	264044h	1,425	4,862	125
	999	264045h	1,520	5,186	134
	1,060	264046h	1,615	5,510	142
	1,120	264047h	1,710	5,835	150
1,181	264048h	1,805	6,159	159	
660	512	264049h	1,064	3,630	77
	573	264050h	1,197	4,084	86
	634	264051h	1,330	4,538	96
	695	264052h	1,463	4,992	105
	756	264053h	1,596	5,446	115
	816	264054h	1,729	5,899	125
	877	264055h	1,862	6,353	134
	938	264056h	1,995	6,807	144
	999	264057h	2,128	7,261	153
	1,060	264058h	2,261	7,715	163
	1,120	264059h	2,394	8,168	173
1,181	264060h	2,527	8,622	182	
960	512	264061h	1,576	5,377	98
	573	264062h	1,773	6,049	111
	634	264063h	1,970	6,722	123
	695	264064h	2,167	7,394	135
	756	264065h	2,364	8,066	147
	816	264066h	2,561	8,738	160
	877	264067h	2,758	9,410	172
	938	264068h	2,955	10,082	184
	999	264069h	3,152	10,755	196
	1,060	264070h	3,349	11,427	209
	1,120	264071h	3,546	12,099	221
1,181	264072h	3,743	12,771	233	

Please note: Due to the weight of the product a 2-man lift is required and there is a £90 incl. VAT shipping charge per order, per destination for orders under £1800 incl. VAT.

The delivery driver is only able to stop at the closest point on the road at the nearest accessible external hard standing, i.e. pavement.

Due to health and safety legislation the driver is prohibited from lifting any heavy goods (25kg = max. single person lift). They are not insured to enter the property. It is your responsibility to organise the manpower thereafter to be available to move your radiators to a suitable and dry storage area.

Cast Iron Column radiators are delivered individually wrapped with each individual radiator layer separated with a thick card then secured flat onto the pallet(s).

Cast Iron Column radiators have up to a 14 day lead time.

Returning Costs: To return a Cast Iron Column radiator(s) there is a restock charge of £42.00 per radiator (inclusive of VAT) and a carrier charge of £90.00 (inclusive of VAT). If there are more than five radiators being returned the carrier charge may increase, this will be discussed when you make your return request to Stelrad.

SIZES AND HEATING SPECIFICATIONS

MINI TOWEL RAIL



50Δt

(75/65/20°C)

Height mm	Length mm	STRAIGHT WHITE			STRAIGHT CHROME		
		Stelrad UIN	Watts	Heat output Btu/hr	Stelrad UIN	Watts	Heat output Btu/hr
678	400	147000h	273	931	147001h	175	597

CLASSIC TOWEL RAIL



50Δt

(75/65/20°C)

Height mm	Length mm	STRAIGHT WHITE			STRAIGHT CHROME		
		Stelrad UIN	Watts	Heat output Btu/hr	Stelrad UIN	Watts	Heat output Btu/hr
760	500	148070h	376	1282	147002h	246	839
	600	148071h	445	1517	147003h	294	1003
1211	500	148072h	576	1964	147004h	379	1292
	600	148073h	686	2339	147005h	453	1545
1744	500	148074h	844	2878	142768h	557	1899
	600	148075h	1000	3410	142769h	667	2274

Height mm	Length mm	CURVED WHITE			CURVED CHROME		
		Stelrad UIN	Watts	Heat output Btu/hr	Stelrad UIN	Watts	Heat output Btu/hr
760	500	147006h	376	1282	147012h	246	839
	600	147007h	445	1517	147013h	294	1003
1211	500	147008h	576	1964	147014h	379	1292
	600	147009h	686	2339	147015h	453	1545
1744	500	147010h	844	2878	147016h	557	1899
	600	147011h	1000	3410	147017h	667	2274

STAINLESS STEEL TOWEL RAIL

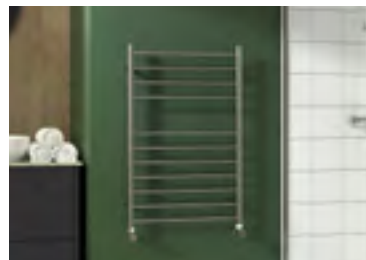

50Δt

(75/65/20°C)

Height mm	Length mm	POLISHED STEEL			BRUSHED STEEL		
		Stelrad UIN	Watts	Heat output Btu/hr	Stelrad UIN	Watts	Heat output Btu/hr
750	500	741001h	190	648	742001h	190	648
	500	741002h	299	1020	742002h	299	1020
1200	600	741003h	340	1160	742003h	340	1160
	500	741004h	370	1262	742004h	370	1262

COMO



50Δt

(75/65/20°C)

Height mm	Length mm	STRAIGHT		
		Stelrad UIN	Watts	Heat output Btu/hr
750	500	720001h	247	843
1000	500	720002h	306	1044
1200	500	720003h	341	1164
1500	500	720004h	421	1437

CALIENTE RAIL

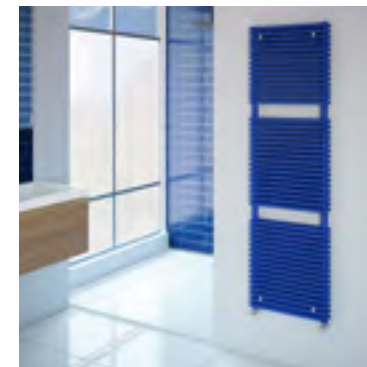

50Δt

(75/65/20°C)

Height mm	Length mm	STRAIGHT SINGLE			STRAIGHT DOUBLE		
		Stelrad UIN	Watts	Heat output Btu/hr	Stelrad UIN	Watts	Heat output Btu/hr
755	450	407501450h	389	1327	407502450h	565	1928
	500	407501500h	431	1471	407502500h	626	2136
	600	407501600h	517	1764	407502600h	749	2556
	750	407501750h	645	2201	407502750h	934	3187
1199	450	401101450h	615	2098	401102450h	868	2962
	500	401101500h	675	2303	401102500h	963	3286
	600	401101600h	794	2709	401102600h	1154	3937
	750	401101750h	972	3316	401102750h	1441	4917
1791	450	401701450h	900	3071	401702450h	1268	4326
	500	401701500h	986	3364	401702500h	1402	4784
	600	401701600h	1158	3951	401702600h	1670	5698
	750	401701750h	1416	4831	401702750h	2073	7073
2013	450	402001450h	1002	3419	402002450h	1427	4869
	500	402001500h	1099	3750	402002500h	1576	5377
	600	402001600h	1294	4415	402002600h	1874	6394
	750	402001750h	1586	5411	402002750h	2321	7919

UINs are for the white products and colour codes can be provided upon request.



We recommend a Centre Tap TRV to complete the look. See page 143 for more information.

SIZES AND HEATING SPECIFICATIONS

CONCORD RAIL

50Δt
(75/65/20°C)

STRAIGHT



Height mm	Length mm	Stelrad UIN	Watts	Heat output Btu/hr
731	450	148581h	342	1167
	600	148582h	447	1525
1186	450	148583h	530	1808
	600	148584h	694	2368
1511	450	148585h	666	2272
	600	148586h	869	2965
1771	450	148587h	777	2651
	600	148588h	1010	3446

UINs are for the white products and colour codes can be provided upon request.



We recommend a Centre Tap TRV to complete the look. See page 143 for more information.

CONCORD SIDE CONCEPT

50Δt
(75/65/20°C)

STRAIGHT

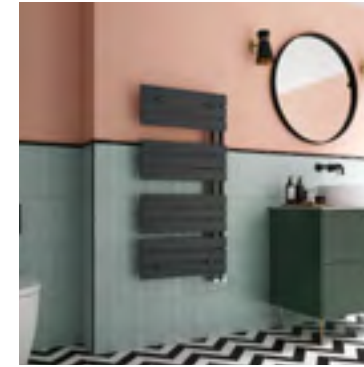

Height mm	Length mm	Stelrad UIN	Watts	Heat output Btu/hr
830	500	711001h	374	1276
1130	500	711002h	483	1648
1430	500	711003h	602	2054



We recommend a Centre Tap TRV to complete the look. See page 143 for more information.

CONCORD SIDE CHROME

50Δt
(75/65/20°C)

STRAIGHT



Height mm	Length mm	Stelrad UIN	Watts	Heat output Btu/hr
830	500	712001h	221	754
1130	500	712002h	297	1013
1430	500	712003h	371	1266
1730	500	712004h	448	1529



We recommend a Centre Tap TRV to complete the look. See page 143 for more information.

EXCLUSIVE TO STELRAD GROUP PLC LECCO

50Δt
(75/65/20°C)

STRAIGHT



Height mm	Length mm	Stelrad UIN	Watts	Heat output Btu/hr
1200	500	730001h	200	682

SIZES AND HEATING SPECIFICATIONS

ULTRA

50Δt

(75/65/20°C)



P+

Front Panel Height mm	Emitter Height mm	Front Panel Length mm	Emitter Length mm	Stelrad UIN	Heat output Watts	Heat output Btu/hr
645	600	470	400	83612104h	474	1616
		670	600	83612106h	710	2,24
		870	800	83612108h	947	3232
		1070	1000	83612110h	1184	4040
		1270	1200	83612112h	1421	4848
		1470	1400	83612114h	1658	5656
		1670	1600	83612116h	1894	6464
		1870	1800	83612118h	2131	7272
		2070	2000	83612120h	2368	8080

K2

Front Panel Height mm	Emitter Height mm	Front Panel Length mm	Emitter Length mm	Stelrad UIN	Heat output Watts	Heat output Btu/hr
545	500	470	400	83512204h	522	1781
		670	600	83512206h	782	2668
		870	800	83512208h	1043	3559
		1070	1000	83512210h	1304	4449
		1270	1200	83512212h	1565	5340
		1470	1400	83512214h	1826	6231
		1670	1600	83512216h	2086	7118
		1870	1800	83512218h	2347	8008
		2070	2000	83512220h	2608	8899
645	600	470	400	83612204h	599	2044
		670	600	83612206h	899	3068
		870	800	83612208h	1198	4088
		1070	1000	83612210h	1498	5111
		1270	1200	83612212h	1798	6135
		1470	1400	83612214h	2097	7155
		1670	1600	83612216h	2397	8179
		1870	1800	83612218h	2696	9199
		2070	2000	83612220h	2996	10223

ULTRA TOWEL RAIL BAR

Fits emitter length	Stelrad UIN
400mm wide	83100004
600mm wide	83100006
800mm wide	83100008
1000mm wide	83100010

Towel rail bar is 120mm wider than actual radiator. Maximum of two towel rail bars per radiator. For more information see accessories page 142.

VERTICAL ULTRA



50Δt

(75/65/20°C)

K2

Front Panel Height mm	Emitter Height mm	Front Panel Length mm	Emitter Length mm	Stelrad UIN	Heat output Watts	Heat output Btu/hr
1040	1000	470	400	86110224h	857	2924
		570	500	86110225h	1071	3654
		670	600	86110226h	1285	4384
1240	1200	470	400	86112224h	999	3409
		570	500	86112225h	1249	4262
		670	600	86112226h	1499	5115
1840	1800	470	400	86118224h	1476	5036
		570	500	86118225h	1845	6295
		670	600	86118226h	2214	7554
2040	2000	470	400	86120224h	1584	5405
		570	500	86120225h	1980	6756
		670	600	86120226h	2376	8107



We recommend a Centre Tap TRV to complete the look. See page 143 for more information.

VERTICAL ULTRA TOWEL RAIL BAR

Fits emitter length	Stelrad UIN	Radiator Height	Max no. of bars
400mm wide	83200004	1000	1
500mm wide	83200005	1200	2
600mm wide	83200006	1800	3
		2000	3

Towel rail bar is 120mm wider than actual radiator. Maximum of three towel rail bars per radiator. For more information see accessories page 142.

ACCESSORIES

COLUMN HORIZONTAL FLOOR MOUNTING BRACKETS (SOLD IN PAIRS)



Column Horizontal in Traffic White RAL 9016 UIN 148137
 Column Concept in Anthracite grey A7016 UIN 148138

TOWEL RAIL ELECTRIC HEATER ELEMENT

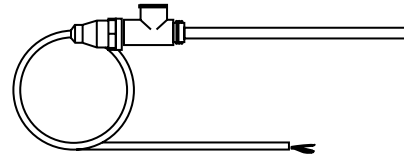

Electric heating element
 150 watt UIN 141536
 300 watt UIN 141531
 615 watt UIN 141532
 Available for the Classic Towel Rail, Stainless Steel Towel Rail, Caliente Rail, Concord Rail, Como & Lecco.

FLOOR MOUNTING BRACKETS (SOLD AS SINGLES)



300mm UIN 9179
 450mm UIN 9180
 600mm UIN 9181
 Available for Classic, Vertical Line, Horizontal Line & Flat.
 Recommended to use 3 on products that are 1800mm or longer.

ADDITIONAL TRVS



Chrome Straight UIN 145340
 White straight UIN 145338
 Chrome Angle UIN 145339
 White Angle UIN 145337
 Antique Brass UIN 263060
 Brushed Nickel UIN 263061
 10mm Push Fit Elbow UIN 145341

VERTICAL ULTRA TOWEL RAIL BAR



400mm UIN 83200004
 500mm UIN 83200005
 600mm UIN 83200006
 Maximum of three bars.

ULTRA TOWEL RAIL BAR



400mm wide UIN 83100004
 600mm wide UIN 83100006
 800mm wide UIN 83100008
 1000mm wide UIN 83100010
 Maximum of two bars.

CENTRE TAP TRV

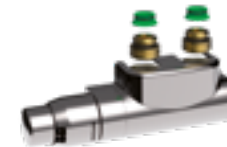

UIN	Elements
14531310	CENTRE TAP TRV STRAIGHT WHITE -10MM
14531312	CENTRE TAP TRV STRAIGHT WHITE -1/2IN
14531315	CENTRE TAP TRV STRAIGHT WHITE -15MM
14531410	CENTRE TAP TRV STRAIGHT CHROME -10MM
14531412	CENTRE TAP TRV STRAIGHT CHROME -1/2IN
14531415	CENTRE TAP TRV STRAIGHT CHROME -15MM
14531510	CENTRE TAP TRV ANGLED L WHITE -10MM
14531512	CENTRE TAP TRV ANGLED L WHITE -1/2IN
14531515	CENTRE TAP TRV ANGLED L WHITE -15MM

UIN	Elements
14531610	CENTRE TAP TRV ANGLED L CHROME -10MM
14531612	CENTRE TAP TRV ANGLED L CHROME -1/2IN
14531615	CENTRE TAP TRV ANGLED L CHROME -15MM
14531710	CENTRE TAP TRV ANGLED R WHITE -10MM*
14531712	CENTRE TAP TRV ANGLED R WHITE -1/2IN*
14531715	CENTRE TAP TRV ANGLED R WHITE -15MM*
14531810	CENTRE TAP TRV ANGLED R CHROME -10MM*
14531812	CENTRE TAP TRV ANGLED R CHROME -1/2IN*
14531815	CENTRE TAP TRV ANGLED R CHROME -15MM*

Available for the Vertical Line Vertical, Flat Vertical, Caliente Rail,* Concord Rail,* Vertical Ultra, Concord Side Concept, Concord Side Chrome, Vertical Line Vertical Concept & Flat Vertical Concept.
 *Angled Right Centre Tap TRVs only available for towel rails.

OUR CUSTOMERS LOVE US

Rated 'Excellent' on  Trustpilot

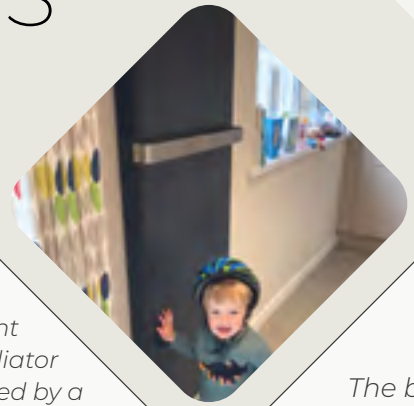

Excellent quality radiator recommended by a plumber mate. As they say you get what you pay for and we are extremely happy with our purchase
@Chris



The best! Great radiators, easy to use website, quick delivery
@Andrew C



Excellent customer service, excellent radiators
@Bernadette



Could not ask for a better service in all aspects of my order, so pleased thank you
@Roger H

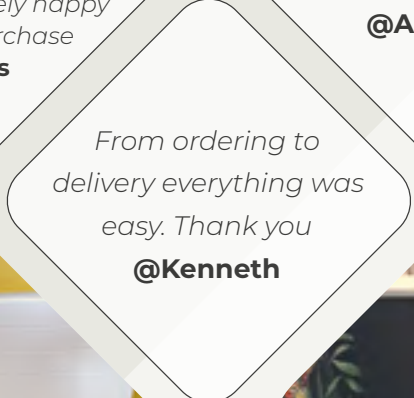

From ordering to delivery everything was easy. Thank you
@Kenneth



Good quality product for the price. Super service: delivery and support, will defo use again
@Chris G

Fantastic service! I chose the radiators I wanted, paid for them and they arrived as promised a couple of days later. The radiators were well packaged and all in perfect condition.
@Holly



Excellent service with very helpful staff. The three radiators arrived well packed and the deliveries were well organised
@Margaret



Excellent service and good communication. The website is very clear making accurate choice straight forward. Delivery was on time
@Mr Bath

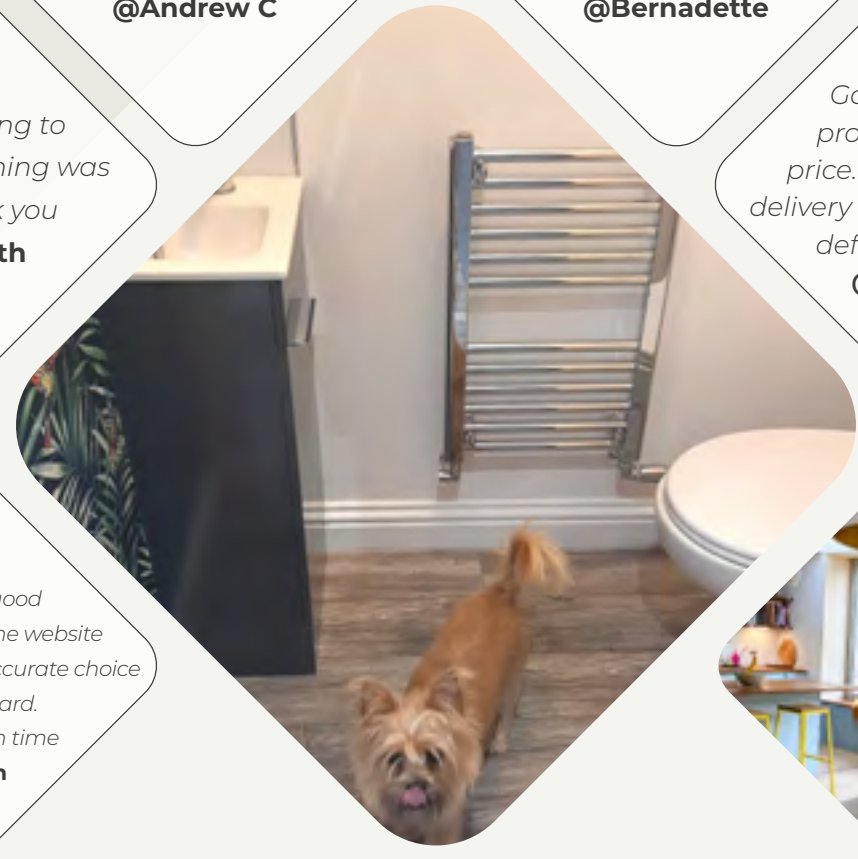

Lovely radiator, looks as good as picture on the web
@Linda



Use **#Stelrad** and mention **@Stelrad** so we can feature you in future marketing material



Excellent product and service. Thanks
@Chris



The Stelrad logo features a stylized square icon with a blue top-left triangle and a red bottom-right triangle, followed by the brand name "Stelrad" in a bold, white, sans-serif font with a registered trademark symbol.

HOME

SERIES

Keep in touch, call us on
0800 876 6813 or email
Sales@Stelrad.com

Follow us on



Stelrad Limited, Stelrad House, Marriott Road, Mexborough, South Yorkshire, S64 8BN

www.stelrad.com

UIN: 20422 Code: SHS/PDF/0123

