

DESIGNER

SERIES



**COMPACT
WITH STYLE
HORIZONTAL**

COMPACT WITH STYLE HORIZONTAL



50 Δ t

(75/65/20°C)

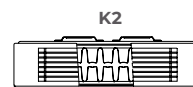

Height mm	Length mm	Stelrad UIN	Heat output		Stelrad UIN	Heat output	
			Watts	Btu/hr		Watts	Btu/hr
300	500	7431105	235	802	7432205	465	1587
	1000	7431110	469	1601	7432210	929	3171
	1400	7431114	657	2242	7432214	1301	4440
	2000	7431120	938	3201	7432220	1858	6341
500	400	7451104	298	1017	7452204	555	1894
	600	7451106	448	1529	7452206	833	2843
	700	7451107	522	1781	7452207	972	3316
	800	7451108	597	2038	7452208	1110	3788
	900	7451109	671	2289	7452209	1249	4262
	1000	7451110	746	2546	7452210	1388	4737
	1100	7451111*	821	2801	7452211*	1527	5210
	1200	7451112	895	3055	7452212	1666	5686
	1400	7451114	1044	3563	7452214	1943	6631
	1600	7451116	1194	4075	7452216	2221	7580
	1800	7451118	1343	4584	7452218	2498	8526
	2000	7451120	1492	5092	7452220	2776	9474
600	400	7461104	348	1188	7462204	640	2184
	600	7461106	522	1782	7462206	961	3280
	700	7461107	609	2078	7462207	1121	3825
	800	7461108	696	2375	7462208	1281	4372
	900	7461109	783	2672	7462209	1441	4917
	1000	7461110	870	2969	7462210	1601	5464
	1100	7461111*	957	3265	7462211*	1761	6009
	1200	7461112	1044	3563	7462212	1921	6556
	1400	7461114	1218	4157	7462214	2241	7649
	1600	7461116	1392	4751	7462216	2562	8744
	1800	7461118	1566	5345	7462218	2882	9836
	2000	7461120	1740	5939	7462220	3202	10928

Δ t50 is the UK's industry standard for heating outputs, which has an operating temperature of 75/65/20°C. If you have a low temperature heat source you may wish to consider Δ t40 or Δ t30 output (see your installer or system designer or download from www.stelrad.com).

For EN442 data, technical and installation information please visit our website: www.stelrad.com and search product downloads.

Piping connections are the same as the Stelrad Compact.

COMPACT WITH STYLE HORIZONTAL



WALL MOUNTING INFORMATION

All dimensions in mm. Inches in brackets. Floor mounting brackets available.

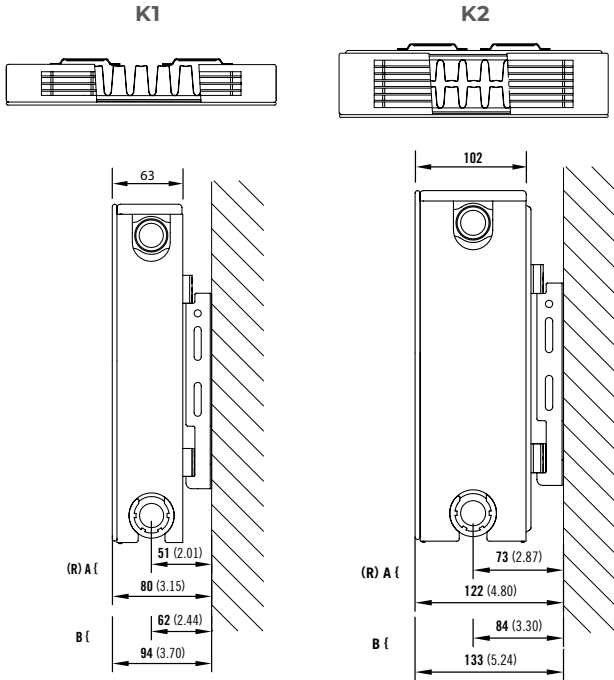

MOUNTING BRACKETS

All dimensions in mm. Inches in brackets. Floor mounting brackets available.

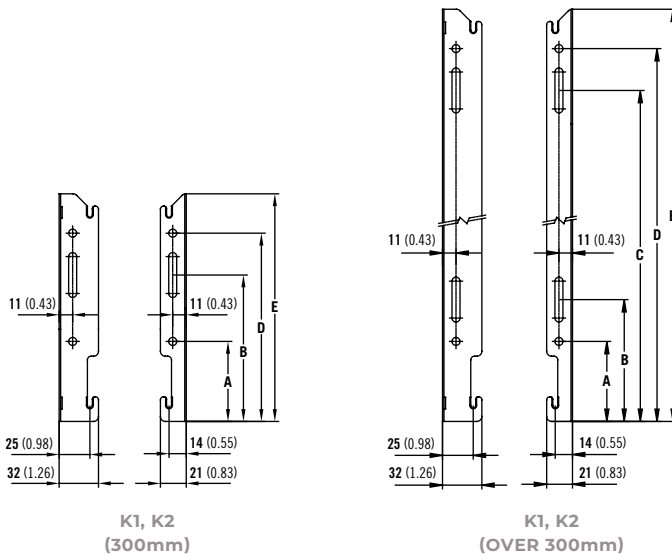

COMPACT WITH STYLE HORIZONTAL



K1 AND K2 LUG POSITIONS (New as of June 2016).
All dimensions in mm. Inches in brackets.

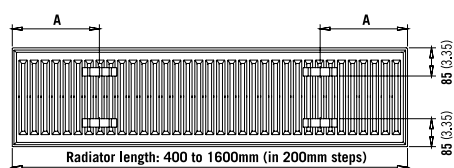
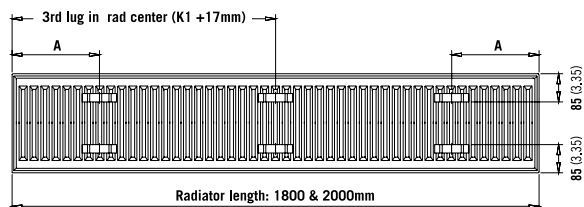

Length	K1		K2	
	mm	mm	mm	mm
400mm	117	4.61	133	5.24
500 - 1000mm	150	5.91	133	5.24
1200 - 1600mm	133	5.24	133	5.24
1800 - 2000mm	3rd lug in rad. centre*			

*K1 + 17mm

CONNECTIONS

Each radiator comes with ½" inlet connections as standard.

PIPING OPTIONS

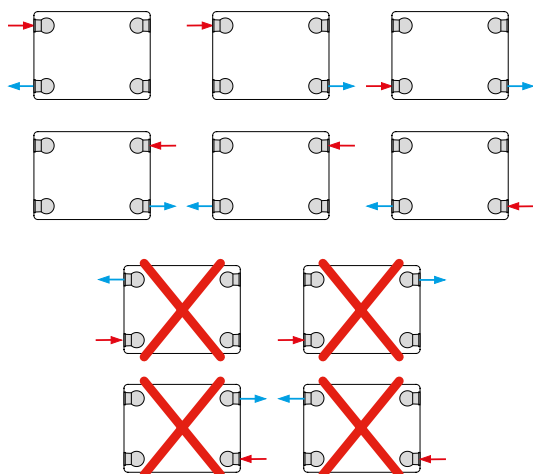

COMPACT WITH STYLE HORIZONTAL



EN 442 CERTIFICATION DATA - CETIAT TESTED IN ACCORDANCE WITH BS EN 442

Type	K1			K2		
	300	500	600	300	500	600
Height	300	500	600	300	500	600
W/m at 75/65/20	470	746	870	898	1388	1601
n-coefficients	1.26	1.28	1.28	1.30	1.31	1.31
Heated surface area (m ² /m)	2.09	3.80	4.66	3.51	6.33	7.74
Weight (kg/m)	14.13	20.23	24.27	19.30	32.03	38.40
Water contents (l/m)	1.81	2.77	3.23	3.10	5.17	6.20
Wall to tap centre (mm)	54	54	54	-	-	-
Floor standing	-	-	-	76	76	76

PRESSURE DROPS

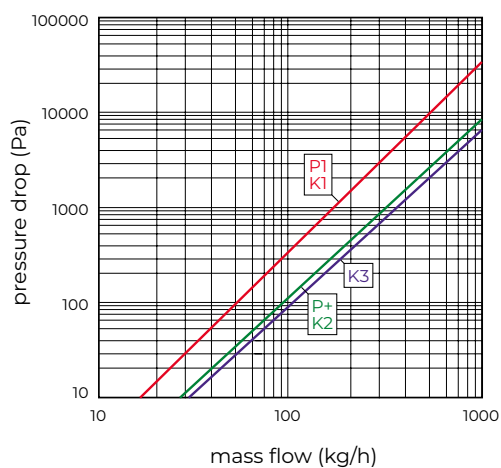

Type	Kv
P1 / K1	1.67
P+ / K2	3.32
K3	3.65

A shade for every room, for every interior. Opt for warm elegance, baroque ambience or modern minimalism.

STANDARD COLOUR

Stelrad Radiators are available in white (RAL 9016) as standard, however the specific radiators identified are now available in a variety of colours.



RAL 9016
Traffic white

NATURAL COLOURS



NT110
Papyrus white



NT120
Pearl white



NT130
Champagne



NT140
Beige

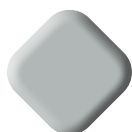

NT160
Pebble grey

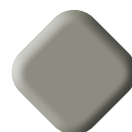

NT170
Quartz grey



SN110
Cream white



SN120
Cream



SN130
Mocca



SN140
Bordeaux



SN150
Sepia

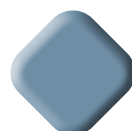

SN160
Pale blue

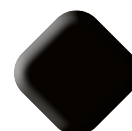

SN170
Black

METALLIC COLOURS



ML110
Dove grey

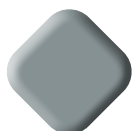

ML120
Titanium grey

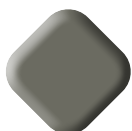

ML140
Granite



ML150
Cappuccino

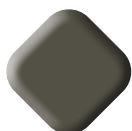

ML160
Terra brown

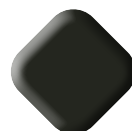

ML170
Graphite black

RAL COLOURS



A1004
Golden yellow



A2003
Pastel orange



A3002
Carmine red



A5002
Ultramarine blue



A6018
Yellow green

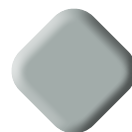

A7001
Silver grey

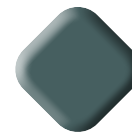

A7011
Iron grey

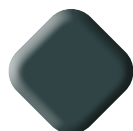

A7016
Anthracite grey

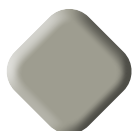

A7030
Stone grey



A7035
Light grey



A8017
Chocolate brown



A9003
Signal white

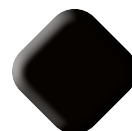

A9005
Jet black

*Please note: When choosing a colour only the front fascia panel can be coloured. Where the product height is 1000mm and 1200mm, the emitter, top grille and side panels are black. If the product height is 1800mm and 2000mm, the emitter, top grille and side panels are white.

FOR FURTHER INFORMATION ON RAL COLOURS PLEASE VISIT WWW.RALCOLOR.COM

The colours shown are reproduced as accurately as this process will allow and can be made to order on the identified products. All colour radiators have up to an 8 week lead time, and when a coloured radiator or radiators have been ordered they cannot be cancelled or returned. To request a colour chart please email marketing@stelrad.com